

Operating Instructions

Blu-ray Disc Recorder

Model No. **DMR-BW500**



DIGA

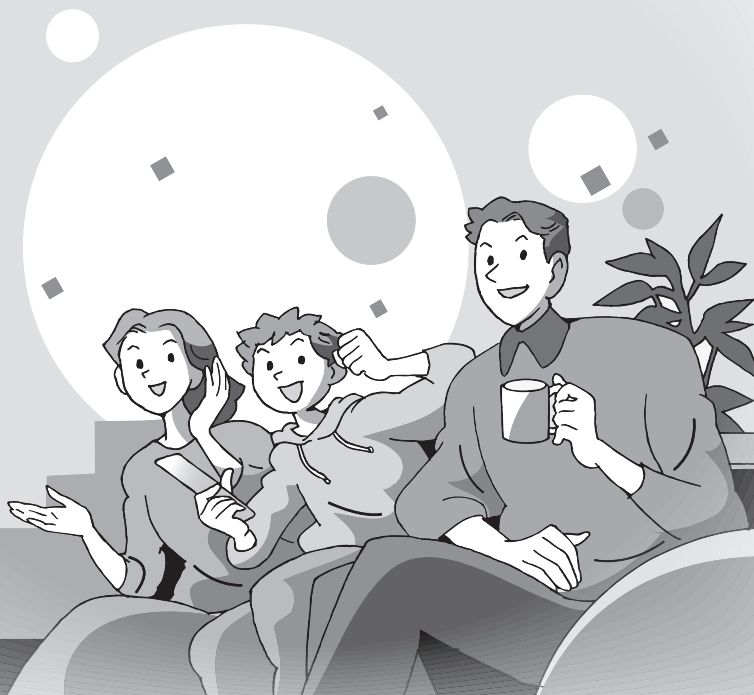

Panasonic®

Quick Start
Guide

Basic
operations

Region management information

BD-Video

This unit plays BD-Video marked with labels containing the region code B.

Example:



DVD-Video

This unit plays DVD-Video marked with labels containing the region number "4" or "ALL".

Example:



Dear customer

Thank you for purchasing this product. For optimum performance and safety, please read these instructions carefully.

Before connecting, operating or adjusting this product, please read the instructions completely. Please keep this manual for future reference.

This Blu-ray Disc Recorder is for viewing and recording free to view channels only, not pay TV or encrypted channels.

Trademark of the DVB Digital Video Broadcasting Project (1991 to 1996)
Declaration of Conformity No. 5367, 25th January 2008

Notice for DVB functions

- Any function related to DVB (Digital Video Broadcasting) will work in areas where DVB-T (MPEG2) digital terrestrial broadcasting is received. Consult your local Panasonic dealer with coverage areas.
- This unit has the capability for DVB specifications. But future DVB services cannot be guaranteed.
- This unit does not support MHP (Multimedia Home Platform).

CAUTION!

THIS PRODUCT UTILIZES A LASER.
USE OF CONTROLS OR ADJUSTMENTS OR PERFORMANCE OF PROCEDURES OTHER THAN THOSE SPECIFIED HEREIN MAY RESULT IN HAZARDOUS RADIATION EXPOSURE.
DO NOT OPEN COVERS AND DO NOT REPAIR YOURSELF. REFER SERVICING TO QUALIFIED PERSONNEL.

WARNING:

TO REDUCE THE RISK OF FIRE, ELECTRIC SHOCK OR PRODUCT DAMAGE,
● DO NOT EXPOSE THIS APPARATUS TO RAIN, MOISTURE, DRIPPING OR SPLASHING AND THAT NO OBJECTS FILLED WITH LIQUIDS, SUCH AS VASES, SHALL BE PLACED ON THE APPARATUS.
● USE ONLY THE RECOMMENDED ACCESSORIES.
● DO NOT REMOVE THE COVER (OR BACK); THERE ARE NO USER SERVICEABLE PARTS INSIDE. REFER SERVICING TO QUALIFIED SERVICE PERSONNEL.

CAUTION!

● DO NOT INSTALL OR PLACE THIS UNIT IN A BOOKCASE, BUILT-IN CABINET OR IN ANOTHER CONFINED SPACE. ENSURE THE UNIT IS WELL VENTILATED. TO PREVENT RISK OF ELECTRIC SHOCK OR FIRE HAZARD DUE TO OVERHEATING, ENSURE THAT CURTAINS AND ANY OTHER MATERIALS DO NOT OBSTRUCT THE VENTILATION VENTS.
● DO NOT OBSTRUCT THE UNIT'S VENTILATION OPENINGS WITH NEWSPAPERS, TABLECLOTHS, CURTAINS, AND SIMILAR ITEMS.
● DO NOT PLACE SOURCES OF NAKED FLAMES, SUCH AS LIGHTED CANDLES, ON THE UNIT.
● DISPOSE OF BATTERIES IN AN ENVIRONMENTALLY FRIENDLY MANNER.

CAUTION

Danger of explosion if battery is incorrectly replaced. Replace only with the same or equivalent type recommended by the manufacturer. Dispose of used batteries according to the manufacturer's instructions.

WARNING

THE COPYRIGHT ACT 1968 DOES NOT PERMIT THE UNRESTRICTED USE OF THIS RECORDER TO COPY FILMS, SOUND RECORDINGS OR BROADCASTS TO ANY RECORDING MEDIA. THE ACT ONLY PERMITS TO COPY BROADCASTS FOR PRIVATE AND DOMESTIC PURPOSES IN LIMITED CIRCUMSTANCES. PANASONIC DOES NOT AUTHORISE ANY USE OF THIS RECORDER IN ANY WAY WHICH MAY AMOUNT TO A BREACH OF ANY LAW OR THE RIGHTS OF ANY OWNER OF COPYRIGHT IN FILM OR BROADCAST.

THIS UNIT IS INTENDED FOR USE IN MODERATE CLIMATES.

This product may receive radio interference caused by mobile telephones during use. If such interference is apparent, please increase separation between the product and the mobile telephone.

The socket outlet shall be installed near the equipment and easily accessible.
The mains plug of the power supply cord shall remain readily operable.
To completely disconnect this apparatus from the AC Mains, disconnect the power supply cord plug from AC receptacle.

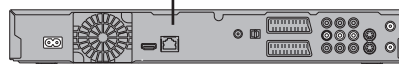

DANGER – VISIBLE AND INVISIBLE LASER RADIATION WHEN OPEN. AVOID DIRECT EXPOSURE TO BEAM. FDA 21 CFR/Class IIb	
CAUTION – CLASS 3B VISIBLE AND INVISIBLE LASER RADIATION WHEN OPEN. AVOID EXPOSURE TO THE BEAM. IEC60825-1 +A2/Class 3B	
ATTENTION – RAYONNEMENT LASER VISIBLE ET INVISIBLE. CLASSE 3B EN CAS D'OUVERTURE, EVITER UNE EXPOSITION AU FAISCEAU.	
FORSIGTIG – SYNLIG OG USYNLIG LASERSTRÅLING KLASSE 3B. NÅR LAGET ER ÅBENT, UNDGÅ AT BLIVE UDSAT FOR STRÅLEN.	
VARO – AVATTAESSA OLET ALTIIN LUKKAN 3B NÄKYVÄÄ JA NÄKYMÄTÖNTÄ LASERSÄTEILYÄ. VÄRÖ ALTIISTUMISTA SÄTEELLE.	
VARNING – KLASS 3B SYNLIG OCH OSYNLIG LASERSTRÅLNING NÄR DENNA DEL ÄR ÖPPNAD. UNDVIK EXPONERING FÖR STRÅLEN.	
VORSICHT – SICHTBARE UND UNSICHTBARE LASERSTRÄHLUNG KLASSE 3B. WENN ABDECKUNG GEÖFFNET, NICHT DEM STRAHL AUSSETZEN.	
注意 – 打开时有可见及不可见激光辐射。避免光束照射。	
注意 – ここを開くと可視及び不可視レーザー光が出ます。ビームを見たり、触れたりしないでください。VOL1J70	

(Inside of product)

Included accessories



Please check and identify the supplied accessories.
(Product numbers correct as of May 2008. These may be subject to change.)



(N2QAYB000271)

1 Remote control



2 Batteries
for remote control



1 AC mains lead
For use with this unit only. Do not use it with other equipment.
Also, do not use cords for other equipment with this unit.



1 RF coaxial cable



1 Audio/video cable

Record with High Definition

It is possible to record in high definition quality when the broadcast is high definition.

→ 7



Record to Blu-ray disc

It can record in high definition quality in addition to large volume recording.

→ 6

Blu-ray disc

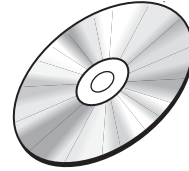

7-Day EPG

Timer recording is made easier because the TV Guide allows you to see programme information up to 7 days ahead.

→ 24

TV Guide		SUN 10/01/08 19:10	
SUN 10/01	Landscape	All Types	All DVB Services
18:00-20:00	Emmerdale	In today's show we will	
Time	19:30	20:00	20:30
1	ABC 2	East...	D.I.Y. SOS
2	ABC 2	Hot Wars	Holiday Programme
3	ITV 1	News	Coronation Street
4	Channel 4	Scrapheap Cha...	Pop Chart Show
5	five	News	Sex and the City
6	ITV 2	Me out of here!	Pop Idol
7	S4C	Rugby	15 to 1

2 programmes Simultaneous Recording

It is possible to record 2 programmes being broadcasted at the same time.

→ 31

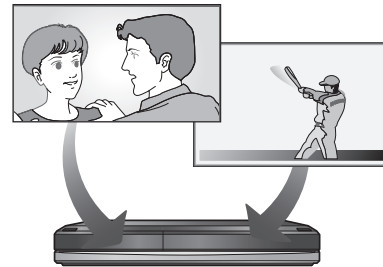

Copy with High Definition Quality

It is possible to input high definition video (AVCHD) from the video camera.

→ 58

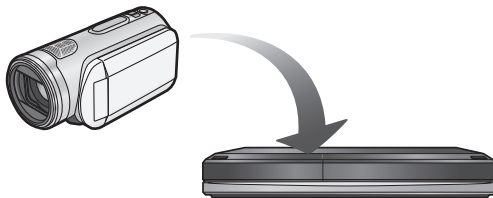

VIERA Link "HDAVI Control™"

Operation of this unit can be controlled by the remote control of the TV (VIERA) by connecting with the HDMI cable to the TV (VIERA).

→ 74

- Pause live TV programme
- Direct TV Recording



Getting started

Getting started

Included accessories	2
Characteristics of this unit	3

Quick Start Guide

HDD and disc information	6
Regarding Blu-ray Disc	6
Regarding DR (Direct Recording) mode	7
HDD and discs you can use for recording and play	8
Play-only discs	10
Discs that cannot be played	10
USB memory and card information	11
USB memories you can use on this unit	11
Cards you can use on this unit	11
Control reference guide	12
Remote control	12
Main unit	13
The unit's display	13
HDD (Hard disk drive) handling care	14
Unit care	14
Media handling (Disc/USB memory/SD card)	15
Inserting discs	15
Inserting, removing the USB memory	15
Inserting, removing the SD card	15
Disc and card care	15
STEP 1 Connection	16
Connecting a television	16
Connecting to a TV with an HDMI (High Definition Multimedia Interface) cable	17
STEP 2 Channel reception settings and TV aspect settings	18

Basic operations

Watching digital broadcasts	20
Select the channel	20
Switching audio of the TV broadcast	20
To show subtitle	20
To show Teletext	21
Digital channel information	21
Playing BD-Video or DVD-Video/Playing recorded video contents	22
Playing BD-Video or DVD-Video	22
Playing recorded video contents	22
Recording television programmes HDD	23
When recording digital broadcast with subtitle or multiple audio	23
To specify a time to stop recording	23
—One Touch Recording	23
Timer Recording (Using the TV Guide System)	24
Programme to HDD	24
Programme to a disc	25
Deleting titles	26
Using the DELETE Navigator to delete	26
Deleting during play	26
Copying titles	27

About descriptions in these operating instructions

- Pages to be referred to are indicated as "▶ ○○".

Title

Recording

Important notes for recording	28
Advanced recording	30
Recording modes	30
2 programmes simultaneous recording	31
Flexible Recording	32
Playing while you are recording	32
Operation during Recording	33
Advanced timer recording	34
Manually programming timer recordings	34
To release the unit from recording standby	35
Relief Recording	35
Auto Renewal Recording	35
To cancel recording when recording has already begun	35
Check, change or delete a programme	36
Notes on timer recording	36
Operations in the TV Guide system	37
TV Guide data download	37

Playing back

Advanced playback	38
Operation during play	38
Changing audio during play	39
Display the subtitle during play	39
Selecting recorded programmes (titles) to play	
— Direct Navigator	40
Switching of the Navigator	40
Playback the title that was viewed once HDD	40
To sort the titles for easy searching	40
To play grouped titles HDD	40
To edit the group of titles HDD	40
Playback of the High Definition Camera Video (AVCHD)	41
Playback of the Playlist created on other equipment	41
Different kinds of playback for BD-Video	42
Showing Pop-up menu	42
To enjoy the BONUS VIEW™ compatible BD-Video	42
Enjoying High Bit rate Audio and Video of BD-Video	43
Regarding High Bit rate Audio	43
Regarding 24p output	43

Editing

Editing titles	44
Title operations	45
Create/Playback/Edit of the Chapter	46
Create Chapter Mark	46
Editing and playing chapters	47
Chapter operations	47

Copying

Copying titles	48
Copy Title Playing	51
Copying using the copying list—Advanced Copy	52
Copying a finalised DVD-R, DVD-R DL, DVD-RW (DVD-Video format), +R and +R DL	54

With Other Equipment

Recording broadcasts from external equipment	55
Copying from a video cassette recorder	56
Manual recording	56
DV automatic recording (DV Auto Rec)	57
Recording via AV3 input	57
Copy the HD Video (AVCHD format) or the SD Video (MPEG 2 format)	58
Copying HD Video (AVCHD format)	58
Copying SD Video (MPEG 2 format)	59

Still pictures

Still pictures

Playing still pictures	60
Useful functions during still picture play	61
Editing still pictures	62
Editing still pictures (JPEG)	62
Still pictures operation	63
Copying still pictures	64
Copying all the still pictures on the USB memory — Copy All Pictures	64
Copying new still pictures on the SD card — Copy New Pictures	64
Copying using the copying list	64

Music

Music

Playing music	66
Playing MP3 files	66
Playing music CD	66
Playing music recorded on HDD	67
Useful functions during music play	68
Editing music/playlist	69
Editing music	69
Album and track operation	69
Register track to Playlist	70
Editing Playlist	70
Playlist operation	70
Copying music to HDD	71
About the Gracenote® Database	71
Copying music from a CD or a USB memory	71

Others

Convenient functions

Deleting still pictures and music using DELETE Navigator	72
Deleting still pictures	72
Deleting music	72
Entering text	73
Linked operations with the TV (VIERA Link “HDAVI Control™”)	74
Easy control only with VIERA remote control	75
Convenient functions to playback and viewing or listening	76
Using on-screen menus	76
Status messages	77
Switch the aspect ratio of the screen	77
FUNCTION MENU window/Pause Live TV	78
FUNCTION MENU window	78
To pause the TV programme you are watching — Pause Live TV	78
Disc and card management	79
Common procedures	79
Setting the protection	79
Providing a name for a disc	79
Deleting all titles—Delete all titles	80
Enabling the unit’s recording function—Format	80
Selecting the background style—Top Menu	81
Selecting whether to show the Top Menu first — Auto-Play Select	81
Enabling discs to be played on other equipment — Finalise	81
Creating Top Menu—Create Top Menu	81
Changing the unit’s settings	82
Common procedures	82
Tuning	82
HDD/Disc	84
Picture	85
Sound	85
Display	86
Connection	87
Network Settings	88
Others	89
Network Settings	90
Other Settings	92
Television operation	92
Child Lock	92
Software Update	93

Reference

Additional connections	94
Connecting a television with S VIDEO terminals	94
Connecting a television with COMPONENT VIDEO terminals	94
Connecting a stereo amplifier	94
Connecting an amplifier with a digital input terminal	94
Connecting with an HDMI compatible television and receiver	95
Connecting an Analogue television and VCR	96
Connecting a Digital television and VCR	97
Network connection	98
Operations that can be performed simultaneously	99
Operations that can be performed while recording or copying a title	99
Starting of the timer recording while executing other operation	99
Frequently asked questions	100
Messages	102
When removing a recorded disc	102
Troubleshooting guide	104
Specifications	112
Glossary	114
Safety precautions	116
Index	118

HDD and disc information

This unit can record or copy to the following HDD or discs.

Internal



To record

It can only record to HDD by pressing [● REC].

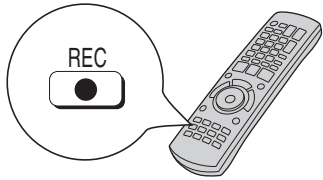

HDD



Can do

Discs



Cannot do

To timer record

It can only record to HDD, BD-RE, BD-R, or DVD-RAM when using timer record.

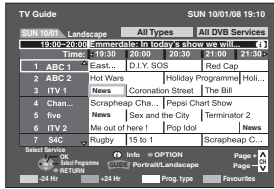

HDD



Can do

BD-RE
BD-R
DVD-RAM



Can do

Other Discs



Cannot do

Record to the HDD and then copy to the disc.

Regarding Blu-ray Disc

1. High volume recording

The Blu-ray Disc (BD-RE and BD-R) has a lot more recording capacity compared with the DVD.

When you compare the Blu-ray Disc (single-side dual-layer 50 GB) with the DVD-R (4.7 GB)

DVD-R (4.7 GB)

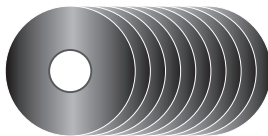

About 10 DVD-Rs

Blu-ray Disc
(50 GB:single-side dual-layer)



When a 2 hour movie is recorded (in SP mode)

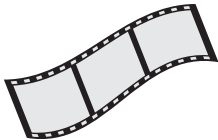

About 1 movie

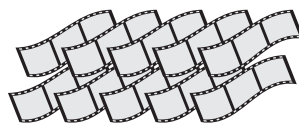

About 10 movies

2. High quality recording

Blu-ray Disc can record the image of the digital broadcasting in the same quality as broadcasted. Therefore, high definition quality can be recorded as high definition quality as it is.

Blu-ray Disc



Broadcasted images can be recorded as they are
(When recorded in DR mode)

DVD-R, etc.



Broadcasted images cannot be recorded as they are
(Cannot record in DR mode)



Various recording modes can be selected when recording or copying is performed on this unit. Time and quality of recording varies depending on the recording mode. (➔ 30, Recording modes)
 The following are characteristics of DR (Direct Recording) mode.

Regarding DR (Direct Recording) mode

This unit can record the digital broadcasting as broadcasted if the record mode is set to DR mode when recording or copying.

The following can be recorded or copied in DR mode



When recording a high definition programme

Quality of the recording depends on the recording mode.

Programmes in high definition (HD) quality



Record as high definition (HD) quality

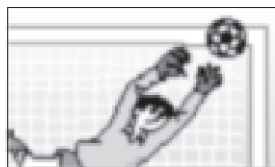

Record as standard definition (SD) quality

When recording a programme with subtitle or multiple audio

Programmes with subtitle or multiple audio

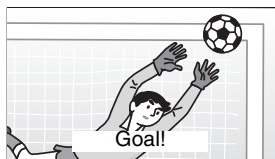

All subtitles and multiple audio are recorded.

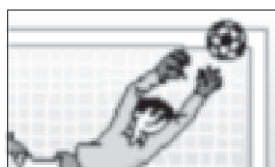

Subtitles cannot be recorded. Only one audio can be recorded for the multiple audio.

• See page 30 for description about the difference of the contents recorded depending on the recording mode.

When copying DR mode titles to disc

- Quality of copying depends on the disc to copy.
- Speed of copying depends on the disc to copy.

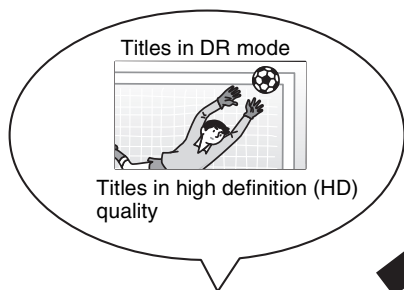

BD-RE
BD-R



- Copy as high definition (HD) quality
- Copy in High Speed mode

All subtitles and multiple audio are copied.

Other Discs





- Copy as standard definition (SD) quality
- Copy in Normal Speed mode





Subtitles cannot be copied. Only one audio can be copied for the multiple audio.

HDD and discs you can use for recording and play

(○): Possible, -: Impossible)

Disc type	Hard disk drive (HDD)	
Standard symbol	HDD	
Data that can be recorded and played	Video Still picture Music	
Quality that can be recorded	High definition (HD) quality Standard definition (SD) quality	
Recording mode that can be recorded	All recording mode (DR, XP, SP, LP, EP, FR)	
Rewritable	○	
Timer recording	○	
Copy-once recording	○	

Disc type	BD-RE  BD-RE	BD-R  BD-R
Standard symbol	BD-RE	BD-R
Data that can be recorded and played	Video Still picture	Video
Quality that can be recorded	High definition (HD) quality Standard definition (SD) quality	
Recording mode that can be recorded	All recording mode (DR, XP, SP, LP, EP, FR)	
Rewritable	○	-
Timer recording	○	
Copy-once recording	○	
Play on other players	It can be played on the players compatible to BD-RE (Ver. 2.1) and BD-R. ● Playback of LTH type BD-R discs may not be possible with players that do not support the LTH type format. ● Single-side dual-layer (50 GB) disc can only be played on the compatible player.	
Note	<ul style="list-style-type: none"> ● DL is also included. “DL” is a single-side dual-layer disc. ● BD-RE (Ver. 1.0) with a cartridge cannot be used with this unit. (It cannot be used even if it is taken out from the cartridge) Use the BD-RE compliant to Blu-ray Disc Rewritable Format Version 2.1. 	<ul style="list-style-type: none"> ● DL is also included. “DL” is a single-side dual-layer disc. ● LTH type is also included.

Disc type	DVD-RAM	DVD-R	DVD-R DL	DVD-RW
Standard symbol	 RAM	 -R before finalisation DVD-V after finalisation	 -R DL before finalisation DVD-V after finalisation	 -RW(V) before finalisation DVD-V after finalisation
Data that can be recorded and played	Video Still picture	Video		
Quality that can be recorded	Standard definition (SD) quality			
Recording mode that can be recorded	XP, SP, LP, EP, FR			
Rewritable	○	-		○
Timer recording	○	-		
Copy-once recording (CPRM)	○ CPRM compatible discs only.	-		
Play on other players	RAM can be played back on Panasonic DVD recorders and DVD-RAM compatible DVD players.	<ul style="list-style-type: none"> Finalisation needed for playback on other equipment. -R DL can be played back only on equipment compatible with this disc. 		
Note	Take the disc out from the cartridge to use the DVD-RAM with a cartridge. (TYPE1 cannot be used)	<ul style="list-style-type: none"> Discs recorded on equipment other than this unit may not be able to be recorded to. 		



Disc type	+R	+R DL	+RW
Standard symbol	+R before finalisation DVD-V after finalisation	+R DL before finalisation DVD-V after finalisation	+RW
Data that can be recorded and played	Video		
Quality that can be recorded	Standard definition (SD) quality		
Recording mode that can be recorded	XP, SP, LP, EP, FR		
Rewritable	-		○
Timer recording	-		
Copy-once recording (CPRM)	-		
Play on other players	<ul style="list-style-type: none"> Finalisation needed for playback on other equipment. +R DL can be played back only on equipment compatible with this disc. 		<ul style="list-style-type: none"> +RW can be played back only on equipment compatible with this disc. If the disc failed to play on other equipment, we recommend you create top menu (➔ 81).
Note	<ul style="list-style-type: none"> +R discs recorded with this unit and +R discs recorded with another Panasonic DVD Recorder may be incompatible. However, discs that are finalised are compatible and can be played. 8X Speed +RW disc is not supported. 		

- This unit cannot record NTSC signals to discs that already have PAL signal recordings. (However, both types of programmes can be recorded onto the HDD, BD-RE or BD-R.)
- You may not be able to record depending on the condition of the discs and you may not be able to play due to the condition of the recording.

■ Regarding 8 cm Disc

This unit cannot record or edit the 8cm BD-RE, BD-R, DVD-RAM, DVD-R, DVD-R DL, DVD-RW, +R DL or +RW.
Only playback or copy to the HDD is possible.

Play-only discs

Disc type	Logo	Standard symbol	Uses
BD-Video		BD-V	High Definition (HD) movie and music discs <ul style="list-style-type: none"> This unit can playback BONUS VIEW™ compatible discs. (⇒ 42) <p style="text-align: right;">BONUS VIEW™</p> <ul style="list-style-type: none"> When playing a set of two or more BD-Video discs, the menu screen may continue to display even if the disc has been ejected. Enjoying High Bit rate Audio and Video of BD-Video (⇒ 43) Operation of this unit may become slower when the BD-J application (⇒ 114) is executing. This is not malfunction.
DVD-Video		DVD-V	Movie and music discs
DVD-RW (DVD Video Recording format)		-RW(VR)	DVD-RW video recorded on another DVD recorder <ul style="list-style-type: none"> You can play programmes that allow One time only recording if they have been recorded onto a CPRM compatible disc. By formatting (⇒ 80) the disc, you can record onto it in DVD-Video format. It may be necessary to finalise the disc on the equipment used for recording.
CD	-	CD	Recorded audio and music (including CD-R/RW*)
		MP3, JPEG	<ul style="list-style-type: none"> CD-R and CD-RW with music recorded in MP3 CD-R and CD-RW with still pictures recorded in JPEG
Disc with high definition video (AVCHD) recorded by other devices	-	AVCHD	<p>Following disc can be played.</p> <ul style="list-style-type: none"> BD-RE, BD-R, DVD-RAM, DVD-R, DVD-R DL, DVD-RW, +R, +R DL, +RW Only the DVD-R, DVD-R DL, DVD-RW(V), +R or +R DL which was finalised (⇒ 114) with the same equipment that was used to record can be played. Set "Play AVCHD on BD-RE/BD-R" to "On" for the disc that has high definition video (AVCHD) recorded by the camcorder and high definition quality title that was recorded on this unit. (⇒ 84)

* Close the session after recording. Play may be impossible on some discs due to the condition of the recording.

- The producer of the disc can control how discs are played. So you may not always be able to control play as described in these operating instructions. Read the disc's instructions carefully.
- Operation and sound quality of CDs that do not conform to CD-DA specifications (copy control CDs, etc.) cannot be guaranteed.

Discs that cannot be played

- BD-RE (Ver.1.0)
- DVD-RAM that cannot be removed from their cartridges
- 2.6 and 5.2 GB DVD-RAM, 12 cm
- 3.95 and 4.7 GB DVD-R for Authoring
- DVD-R, DVD-R DL, DVD-RW, +R, +R DL recorded on another unit and not finalised (⇒ 114).
- BD-Video with a region code other than "B"
- DVD-Video with a region number other than "4" or "ALL"
- DVD-Audio
- HD DVD
- DVD-ROM, +R (8 cm), CD-ROM, CDV, CD-G, Photo CD, CVD, SVCD, SACD, MV-Disc, PD, Video CD, DivX discs, etc.

USB memories you can use on this unit

Compatible USB memories	USB memories which are defined as USB mass storage class: <ul style="list-style-type: none"> – USB memories that support USB 1.0/1.1 and USB 2.0 Full Speed/High Speed. • USB memories of up to 128 GB can be used. • USB memories that support bulk only transfer. CBI (Control/Bulk/Interrupt) is not supported. • Digital Cameras which require additional programme installation when connected to a PC are not supported. • MTP (Media Transport Protocol) device is not supported. • A multi-port USB card reader is not supported. • PTP protocol is not supported.
Format	FAT16 and FAT32 file systems are supported. <ul style="list-style-type: none"> • UDF/NTFS/exFAT file system is not supported. • Depending on the sector size, some files may not work. • Only the first partition on USB memories with multi-partition is supported.
Indicated in these instructions by	USB
Data that can be played	MP3 Still pictures (JPEG)
Data that can be copied	MP3 <ul style="list-style-type: none"> • It can be copied to HDD. Still pictures (JPEG) <ul style="list-style-type: none"> • It can be copied to HDD. SD Video (MPEG2 format) HD Video (AVCHD format) <ul style="list-style-type: none"> • If a Panasonic digital video camera with HDD is connected to this unit's USB port: <ul style="list-style-type: none"> – you can copy the SD Video shot with the camera to this unit's HDD or DVD-RAM. – you can copy the HD Video shot with the camera to this unit's HDD, BD-RE or BD-R.

- Despite meeting the conditions mentioned above, there may be USB memories that cannot be used for this unit.

Note

- This unit's USB port does not support bus-powered USB device.

Cards you can use on this unit

Type	SD Memory Card* (from 8 MB to 2 GB) SDHC Memory Card (from 4 GB to 32 GB) * Including miniSD Card and microSD Card The card types mentioned above will be referred to as "SD card" in these operating instructions.
Indicated in these instructions by	SD
Data that can be played	Still pictures (JPEG) HD Video (AVCHD format)
Data that can be copied	Still pictures (JPEG) <ul style="list-style-type: none"> • It can be copied to HDD, BD-RE or DVD-RAM. SD Video (MPEG2 format) HD Video (AVCHD format) <ul style="list-style-type: none"> • SD Video shot with a Panasonic SD Video camera, etc. can be copied to the HDD or DVD-RAM. (⇒ 59) • HD Video shot with a Panasonic digital camcorder, etc. can be copied to the HDD, BD-RE or BD-R. (⇒ 58)
Instructions	You can insert directly into the SD card slot. * A miniSD Card and a microSD Card must be used with the adaptor that comes with the card.

Suitable SD cards

- When using SD cards 4 GB or larger, only SD cards that display the SDHC logo can be used.
- Useable memory is slightly less than the card capacity.
- Please confirm the latest information on the following website.
<http://panasonic.co.jp/pavc/global/cs>
 (This site is in English only.)
- If the SD card is formatted on other equipment, the time necessary for recording may be longer. Also, if the SD card is formatted on a PC, you may not be able to use it on this unit. In these cases, format the card on this unit (⇒ 80, 114).
- This unit is compatible with SD Memory Cards that meet SD Card Specifications FAT12 and FAT16 formats, as well as SDHC Memory Cards in FAT32 format.
- SDHC Memory Cards used for recording with this unit can only be used with other SDHC Memory Card-compatible equipment. SDHC Memory Cards cannot be used with equipment that is only compatible with SD Memory Cards.
- We recommend using a Panasonic SD card.
- Keep the Memory Card out of reach of children to prevent swallowing.

■ Setting the protection

Switch the write-protect switch to the "LOCK" position.



Remote control

Instructions for operations are generally described using the remote control.

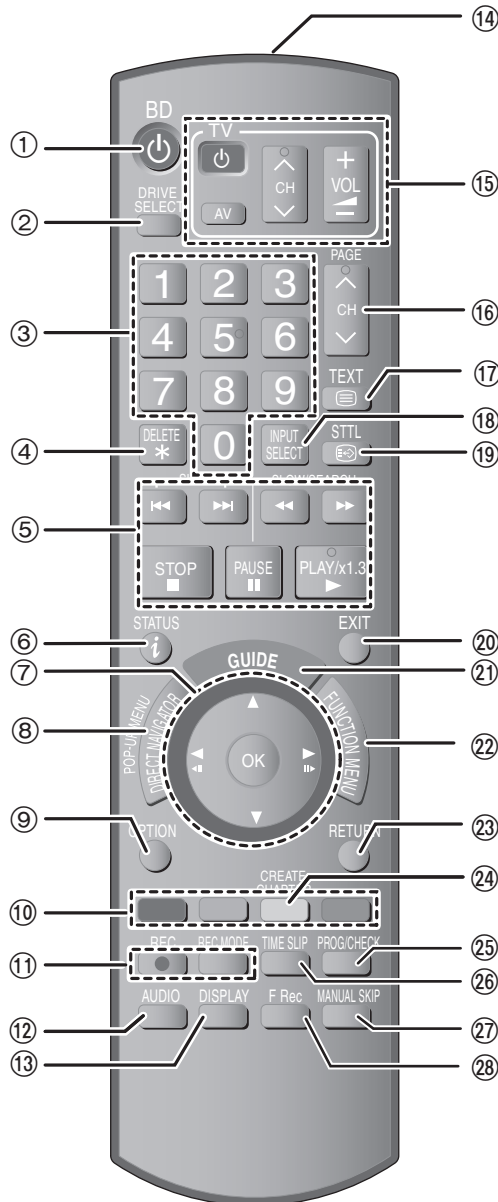

- ① Turn the unit on (⇒ 18)
- ② Select drive (HDD, BD or SD) (⇒ 22, 23, 60)
Drive changes each time you press [DRIVE SELECT].
- ③ Select channels and title numbers, etc./Enter numbers
- ④ To delete unwanted recorded titles, timer programmes, still pictures or music (⇒ 26, 36, 72)
- ⑤ Basic operations for recording and play
- ⑥ Show digital channel information (⇒ 21)/Programme information within TV Guide screen (⇒ 37)/Show status messages (⇒ 77)
- ⑦ Selection/OK, Frame-by-frame (⇒ 38)
- ⑧ Show DIRECT NAVIGATOR (⇒ 22, 60)/Pop-up menu (⇒ 42)
- ⑨ Show OPTION menu (⇒ 44, 62)
This menu is used when playing or editing titles and still pictures, etc.
- ⑩ Colour buttons
Use in accordance with instruction on the screen.
- ⑪ Recording functions
 - [● REC] Start recording (⇒ 23)
 - [REC MODE] Change recording mode (⇒ 23)
- ⑫ Select audio (⇒ 20, 39)
- ⑬ Show on-screen menu (⇒ 76)
- ⑭ Transmit the remote control signal
- ⑮ Television operations (⇒ 92)
- ⑯ Channel select/Change pages in the TV Guide system (⇒ 23, 37)
- ⑰ Show teletext (⇒ 21)
- ⑱ Input select (TV, AV1, AV2, AV3, AV4 or DV) (⇒ 20, 23, 55, 56)
- ⑲ Show subtitles (Subtitles can be viewed if the digital broadcast programme has subtitles.) (⇒ 20)
- ⑳ Exit the menu screen
- ㉑ Show the TV Guide screen (⇒ 20, 24)
- ㉒ Show FUNCTION MENU window (⇒ 78)
By using the FUNCTION MENU window you may access the main functions (Playback, Recording, etc.) quickly and easily.
- ㉓ Return to previous screen
- ㉔ Create chapter (⇒ 46)
- ㉕ Show Timer Recording screen (⇒ 34)
- ㉖ Skip the specified time (⇒ 39)
- ㉗ Skip approx. 1 minute forward (⇒ 39)
- ㉘ Start Flexible Recording (⇒ 32)

Buttons used for BD-Video or DVD-Video

- BD-V**
"Pop-up Menu" → [DIRECT NAVIGATOR]
- DVD-V**
"Top Menu" → [DIRECT NAVIGATOR]
"Menu" → [OPTION]

The remote control information

Batteries

- Insert so the poles (+ and -) match those in the remote control.
- Do not use rechargeable type batteries.

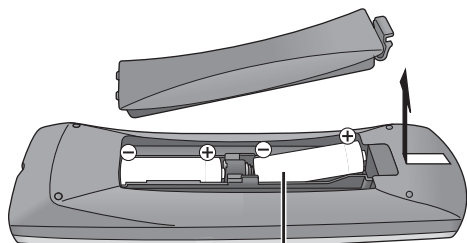

R6/LR6, AA

- Do not mix old and new batteries.
- Do not use different types at the same time.
- Do not heat or expose to flame.
- Do not leave the battery(ies) in an automobile exposed to direct sunlight for a long period of time with doors and windows closed.
- Do not take apart or short circuit.
- Do not attempt to recharge alkaline or manganese batteries.
- Do not use batteries if the covering has been peeled off.

Mishandling of batteries can cause electrolyte leakage which can damage items the fluid contacts and may cause a fire.

Remove if the remote control is not going to be used for a long period of time. Store in a cool, dark place.

Use

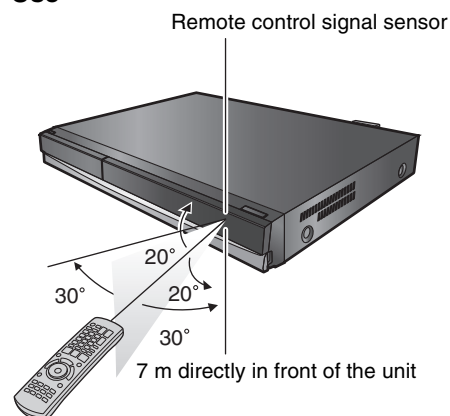

Main unit

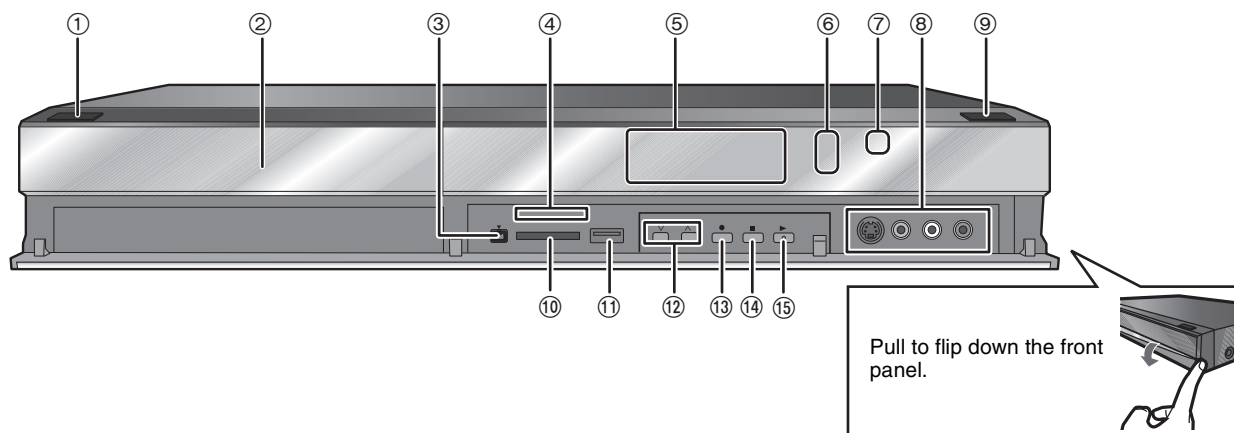

① Standby/on switch (⏻/⏻) (→ 18)

Press to switch the unit from on to standby mode or vice versa. In standby mode, the unit is still consuming a small amount of power.

② Disc tray (→ 15)

③ Connection for digital video (DV) camcorder (→ 56)

④ SD Card LED

- It is possible to set the LED to turn on/off. (→ 86, SD Card LED Control)

⑤ Display (→ below)

⑥ Recording indicator

⑦ Remote control signal sensor

⑧ Connection for VCR, camcorder etc. (→ 55, 56)

⑨ Open/close disc tray (→ 15)

⑩ SD card slot (→ 15)

⑪ USB port (→ 15)

⑫ Channel select (→ 23)

⑬ Start recording (→ 23)/Specify a time to stop recording (→ 23)

⑭ Stop (→ 23, 38)

⑮ Start play

Rear panel terminals (→ 16, 17, 94–98)

The unit's display

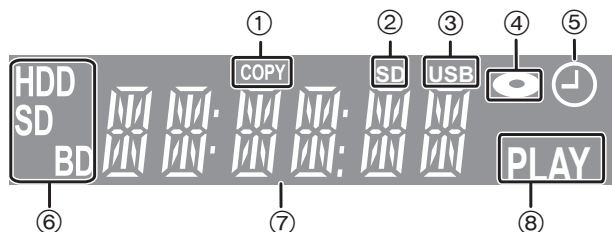

① Copying indicator

② SD card slot indicator

③ USB port indicator

④ Disc indicator

⑤ Timer recording indicator

⑥ Drive (HDD, BD or SD) indicator

⑦ Main display section indicator

⑧ Playback indicator

- Indicators for functions that this unit does not support will not light.

HDD (Hard disk drive) handling care

The HDD is a high precision recording instrument and because of its long recording capability and high speed operation it is a very special device that is easily susceptible to damage.

As a basic rule, save important content to a disc as backup.

■ The HDD is a device that is not built to withstand vibration/shock or dust

Depending on the setup environment and handling of the HDD some content may become damaged and play and recording may no longer be possible. Especially during operation, do not subject the unit to any vibration, shock, or remove the AC mains lead from the household mains socket. In the event of a power failure during recording or play, the content may be damaged.

■ The HDD is a temporary storage device

The HDD is not an everlasting storage device for recorded content. Use the HDD as a temporary storage place for one-off viewing, editing, or copying. It is recommended to save the recorded content on a disc or to keep the original data or CDs that they were copied from.

■ Immediately save (backup) all content as soon as you feel there may be a problem with the HDD

If there is an irregularity within the HDD, repetitive strange sounds or problems with picture (block noise, etc.) may result. Using the HDD in this condition may worsen the problem and in the worst case the HDD may no longer be usable. As soon as you notice this type of problem, copy all content to disc and request service. Recorded content (data) on a HDD that has become unusable is unrecoverable.

- When the unit is turned on or off, there may be an unexpected sound. This does not indicate a problem with this unit.

■ Setup precautions

- Do not place in an enclosed area where the rear cooling fan and the cooling vents on the side are covered up.

- Place the unit on a surface that is flat and not subject to vibration or impact.

- Do not place on anything that generates heat like a video cassette recorder, etc.

- Do not place in an area often subject to temperature changes.

- Place in an area where condensation does not occur. Condensation is a phenomenon where moisture forms on a cold surface when there is an extreme change in temperature. Condensation may cause internal damage to the unit.

● Conditions where condensation may occur

- When there is an extreme change in temperature (moving from a very hot location to a very cold location, or vice versa, or when subjected to an air conditioner or when cooled air directly impacts the unit). When the HDD (warms during operation) is subjected to cold air, condensation may form on the inside of the HDD and may cause damage to the HDD heads, etc.

- When there is high humidity or a lot of steam in the room.

- During the rainy season.

In the above situation, **without turning the unit on**, let the unit adjust to the room temperature and wait 2–3 hours until condensation is gone.

DO NOT

SSS

This unit

VCR

■ Cigarette smoke etc. causes malfunction or breakdown

The unit may breakdown if cigarette smoke or bug spray/vapor, etc. gets inside the unit.

■ While operating

- Do not move the unit or subject to vibration or impact. (The HDD may become damaged.)

- Do not remove the AC mains lead from the household mains socket, or flip the power breaker switch.

While the unit is on, the HDD is rotating at high speed. Sound or movement due to rotation is normal.

■ When moving the unit

- ① Turn the unit off. (Wait until "BYE" disappears from the display.)
- ② Remove the AC mains lead from the household mains socket.
- ③ Move only after the unit has come to a complete stop (approx. 2 minutes) in order to avoid subjecting to vibration and shock. (Even after turning the unit off, the HDD continues operating for a short time.)

■ Indemnity concerning recorded content

Panasonic does not accept any responsibility for damages directly or indirectly due to any type of problems that result in loss of recording or edited content (data), and does not guarantee any content if recording or editing does not work properly. Likewise, the above also applies in a case where any type of repair is made to the unit (including any other non-HDD related component).

Unit care

The precision parts in this unit are readily affected by the environment, especially temperature, humidity, and dust. Cigarette smoke also can cause malfunction or breakdown.

To clean this unit, wipe with a soft, dry cloth.

- Never use alcohol, paint thinner or benzine to clean this unit.

- Before using chemically treated cloth, carefully read the instructions that came with the cloth.

Observe the following points to ensure continued listening and viewing pleasure.

Dust and dirt may adhere to the unit's lens over time, making it impossible to record or play discs.

Use the **Lens cleaner** (not included) about once every year, depending on frequency of use and the operating environment. Carefully read the lens cleaner's instructions before use.

Lens cleaner: RP-CL720E

- This lens cleaner may not be for sale depending on the region.

DO NOT
Do not place the unit on amplifiers or equipment that may become hot.

The heat can damage the unit.

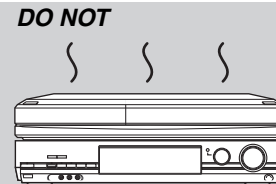

Note

Do not obstruct the rear panel's internal cooling fan.

Before moving the unit, ensure the disc tray is empty. Failure to do so will risk severely damaging the disc and the unit.

Inserting discs

- 1 Press [**▲** OPEN/CLOSE] to open the tray.

Insert label-up.

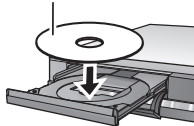

- 2 Press [**▲** OPEN/CLOSE] to close the tray.

Automatic drive select function

BD-V **DVD-V** **CD**

- If the unit is recording to the HDD or stopped, it automatically switches to the BD drive when a disc is inserted.
- If you eject a disc and close the disc tray, the HDD drive is automatically selected.

Disc With a Cartridge

- BD-RE with a cartridge cannot be used with this unit. (It cannot be used even if it is taken out from the cartridge)
- Remove the DVD-RAM or 8 cm disc from the cartridge and place it on the tray. (TYPE1 cannot be used)
Refer to the instructions on how to remove the disc from the cartridge.

Note

- **RAM** It is not possible to record or play continuously from one side of a double sided disc to the other. You will need to eject the disc and turn it over.

Inserting, removing the USB memory

Inserting the USB memory

When the USB memory is flashing, the USB memory is being read from. Do not turn off the unit or remove the USB memory. Such action may result in malfunction or loss of the USB memory's contents.

- Before inserting any USB memory to this unit, ensure that the data stored therein has been backed up.
- Check the orientation of the USB connector and insert it straight in.
- Insert an USB device while the unit is stopped, so the "USB device" screen is displayed. Select an item and press [OK] to switch to the USB-related operations (⇒ 58, 60).

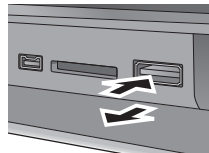

Removing the USB memory

- Complete all USB-related operations and pull the USB memory straight out.
- If a USB memory being accessed is pulled out, then the data may be damaged.

Inserting, removing the SD card

When the card indicator ("SD") on the unit's display is flashing, the card is being read from or written to. Do not turn off the unit or remove the card. Such action may result in malfunction or loss of the card's contents.

- **Inserting foreign objects can cause a malfunction.**

Inserting the card

Press on the centre of the card until it clicks into place.

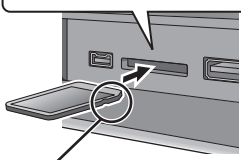

Insert the card label up with the cut-off corner on the right.

If you are using a miniSD card or a microSD card, insert it into the adaptor that comes with the card. Insert and remove this adaptor from the unit.

e.g., miniSD



Removing the card

- 1 Press on the centre of the card.
- 2 Pull it straight out.

Automatic drive select function

- If you insert an SD card while the unit is stopped, the "SD Card" screen is displayed. Select an item and press [OK] to switch to the SD drive (⇒ 58, 60).
- If you remove an SD card, the HDD drive is automatically selected.

Disc and card care

How to hold a disc or card

Do not touch the recorded surface or the terminal surface.

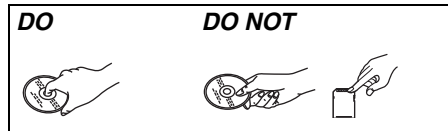

If there is dirt or condensation on the disc

Wipe with a damp cloth and then wipe dry.

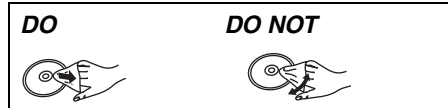

Handling precautions

- Do not attach labels or stickers to discs. (This may cause disc warping and un-balanced rotation, rendering it unusable.)
- Write on the label side of the disc only with a soft, oil-based felt pen. Do not use ballpoint pens or other hard writing implements.
- Do not use record cleaning sprays, benzene, thinner, static electricity prevention liquids or any other solvent.
- Do not use scratch-proof protectors or covers.
- Do not expose the terminals of the card to water, garbage or other strange things.
- Do not drop stack, or impact discs. Do not place objects on them.
- Do not use the following discs:
 - Discs with exposed adhesive from removed stickers or labels (rental discs, etc.).
 - Discs that are badly warped or cracked.
 - Irregularly shaped discs, such as heart shapes.

DO NOT

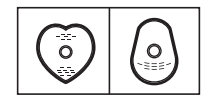

- Do not place in the following areas:
 - In direct sunlight.
 - In very dusty or humid areas.
 - Near a heater.
 - Locations susceptible to significant difference in temperature (condensation can occur).
 - Where static electricity or electromagnetic waves occur.
- To protect discs from scratches and dirt, return them to their cases when you are not using them.

The manufacturer accepts no responsibility and offers no compensation for loss of recorded or edited material due to a problem with the unit or recordable media, and accepts no responsibility and offers no compensation for any subsequent damage caused by such loss.

Examples of causes of such losses are

- A disc recorded and edited with this unit is played in a Blu-ray Disc Recorder or computer disc drive manufactured by another company.
- A disc used as described above and then played again in this unit.
- A disc recorded and edited with a Blu-ray Disc Recorder or computer disc drive manufactured by another company is played in this unit.

STEP 1 Connection

- Before connection, turn off all equipment and read the appropriate operating instructions.
- Refer to “Additional connections” (⇒ 94) for connection using other terminals and connection with other equipment.

When the unit is not to be used for a long time

To save power, unplug it from the household mains socket. This unit consumes a small amount of power, even when it is turned off [approx. 3 W (Power Save mode)]

When “Power Save” is set to “On”, the “Quick Start” function does not work.

Connecting a television

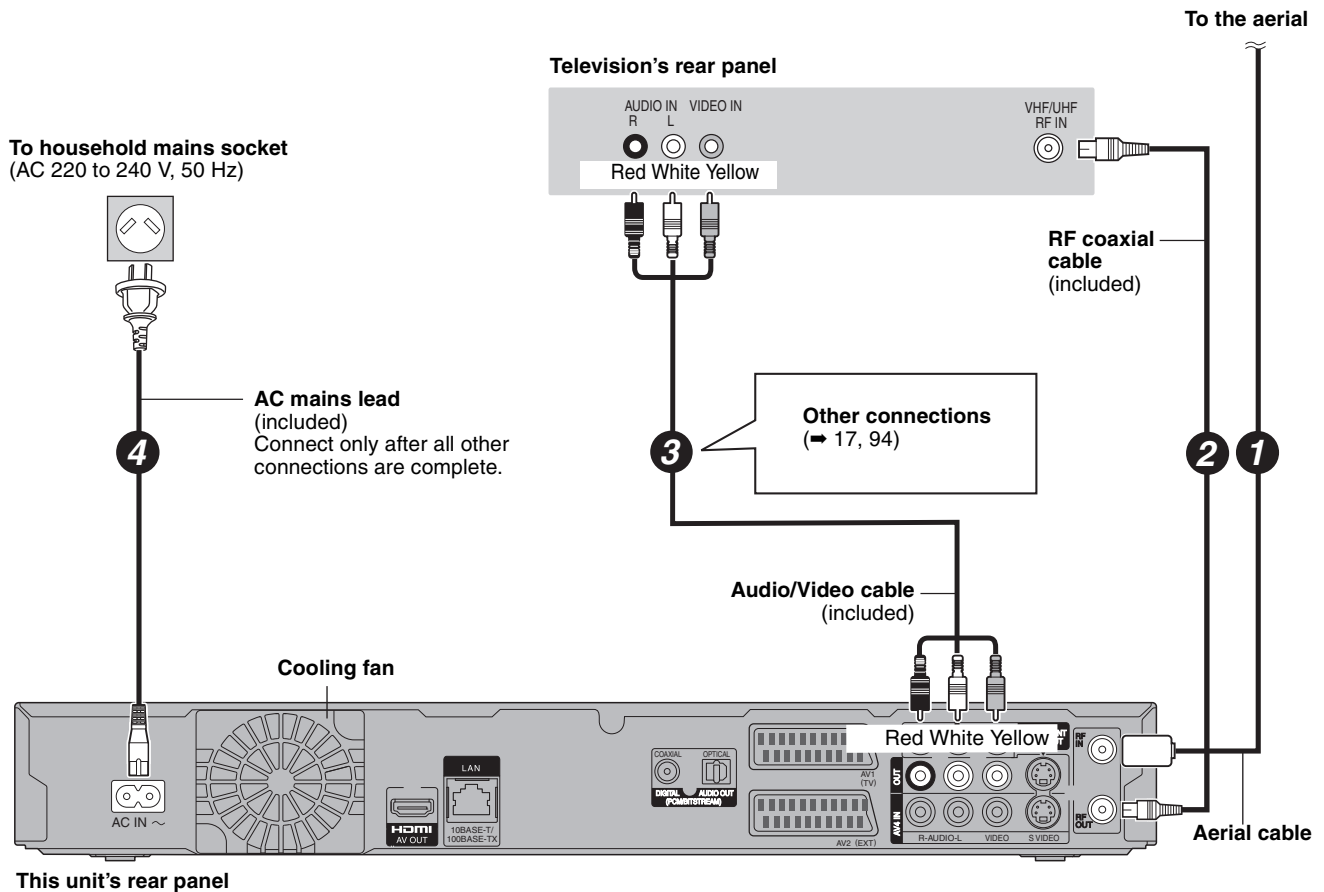

Connecting to a television with 21-pin Scart terminal

You can also connect with the AV1 terminal on this unit using the 21-pin Scart cable.

If your television is equipped with RGB input capability, by connecting with a fully wired 21-pin Scart cable you can see video using RGB output on this unit.

Required setting

“AV1 Output” in the Setup menu (⇒ 88)

You can enjoy high-quality picture by changing the connection between this unit and your TV on page 16 as follows.

Connecting to a TV with an HDMI (High Definition Multimedia Interface) cable

When connected to an HDMI compatible unit, an uncompressed digital audio and video signal is transmitted. You can enjoy high quality, digital video and audio with just one cord. When connecting to an HDMI-compatible HDTV (High Definition Television), the output can be switched to 1080p, 1080i or 720p HD video.

- This unit incorporates HDMI™ (V.1.3 with Deep Colour) technology.
- Video sources converted to 1920×1080 resolution, while of high quality, will exhibit somewhat lower subjective image resolution than true, native 1080p full-HD sources. See dealer for details.
- Please use High Speed HDMI Cables that have the HDMI logo (as shown on the cover).
- When outputting 1080p signal, please use the HDMI cables 5.0 meters or less.

Regarding VIERA Link “HDAVI Control™” function

When connected with a Panasonic TV (VIERA) or a receiver equipped with the “HDAVI Control” function, linked operations would be possible. [➔ 74, Linked operations with the TV (VIERA Link “HDAVI Control™”)]

- **Non-HDMI-compliant cables cannot be utilised.**
- **It is recommended that you use Panasonic’s HDMI cable.**

Recommended part number:

RP-CDHG10 (1.0 m), RP-CDHG15 (1.5 m), RP-CDHG20 (2.0 m), RP-CDHG30 (3.0 m), RP-CDHG50 (5.0 m), etc.

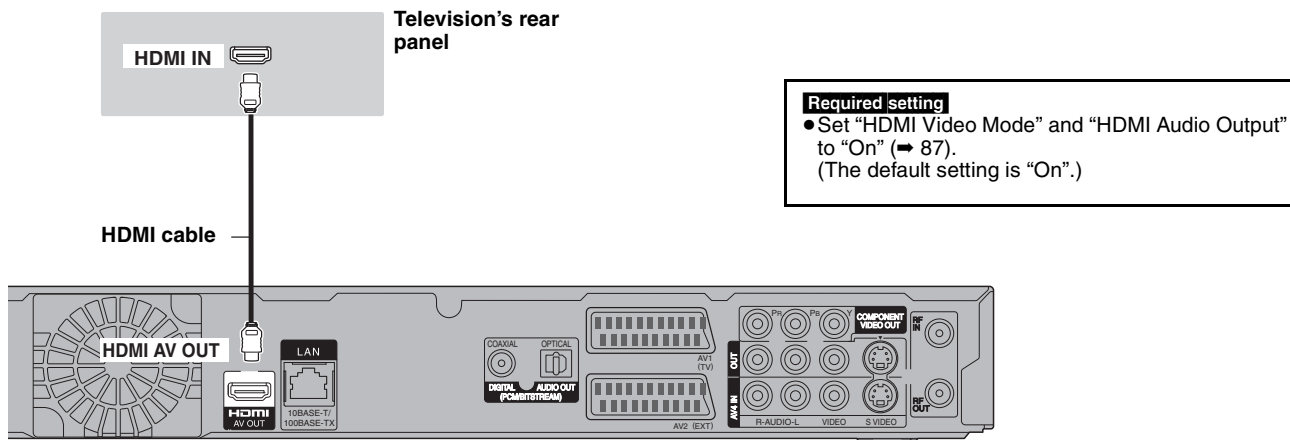

This unit's rear panel

Note

- If you are connecting to a TV that is only compatible with 2 channel audio output, audio with 3 channels or more will be down mixed (➔ 114) and output as 2 channels, even if connecting with an HDMI cable. (Some discs cannot be down mixed.)
 - You cannot connect this unit to DVI devices that are incompatible with HDCP.
- For units compatible with HDCP (High-Bandwidth Digital Content Protection) copyright protection that are equipped with a digital DVI input terminal (PC monitors, etc.):
Depending on the unit, images may not display properly or at all when connecting with a DVI/HDMI switching cable. (Audio cannot be output.)

STEP 2 Channel reception settings and TV aspect settings

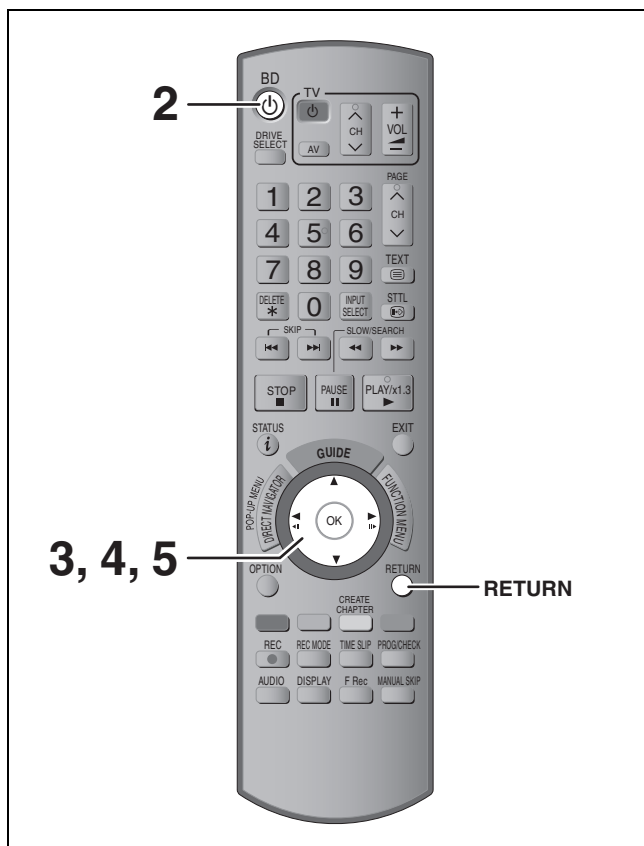

- 1 Turn on the television and select the appropriate AV input to suit the connections to this unit.
- 2 Press [**BD**] to turn the unit on.
When the Download from TV screen appears (➔ 19)
- 3 Press [**▲**, **▼**] to select your region and press [**OK**].

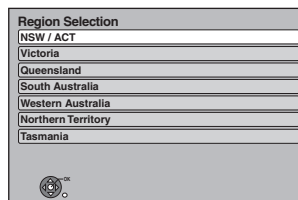

After Region Selection setting is complete, Auto Tuning setting screen appears.

• Auto-Tuning starts.

The unit will search for the terrestrial digital channels. TV channels will be located and stored ready for use. This takes 3 minutes.

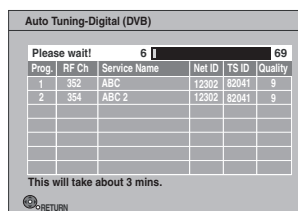

Auto-Tuning is complete when Quick Start setting screen appears.
The time information for your region can be obtained.

4 Press [▲, ▼] to select “On” or “Off” and press [OK].

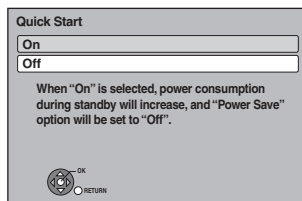

- **On:**
It is possible to start quickly from the power off state.
- **Off:**
It will go into the Power Save mode when the power is turned off.

After Quick Start setting is complete, TV aspect setting screen appears.

5 Press [▲, ▼] to select the TV aspect and press [OK].

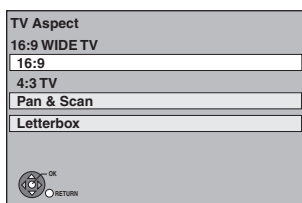

- **16:9:**
When connected to a 16:9 widescreen television
- **Pan & Scan:**
When connected to a 4:3 aspect television, side picture is trimmed for 16:9 picture (⇒ 114).
- **Letterbox:**
When connected to a 4:3 aspect television. 16:9 picture is shown in the letterbox style (⇒ 114).



When television picture appears, set up is complete.

To stop partway
Press [RETURN].

- **To confirm that stations have been tuned correctly (⇒ 83)**
- **To restart set up (⇒ 82)**

Download from the TV

If this unit is connected to a Panasonic TV (VIERA) supporting HDAVI Control 3 via an HDMI cable, then the setting information on the TV is acquired by this unit when the unit is turned on for the first time. Please proceed to the following steps.

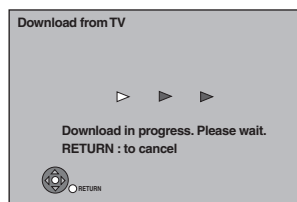

After Download from TV is complete, Quick Start setting screen appears.

Press [▲, ▼] to select “On” or “Off” and press [OK].

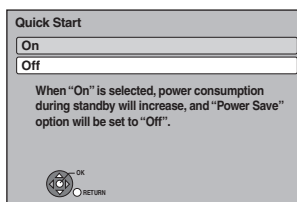

When television picture appears, set up is complete.

To stop partway
Press [RETURN].

Note

- Acquisition of the setting information is not supported by all Panasonic TVs (VIERA).
- The acquisition may take some time depending on the VIERA setting information.
- If Region Selection screen is displayed, please go to step 3 on page 18.

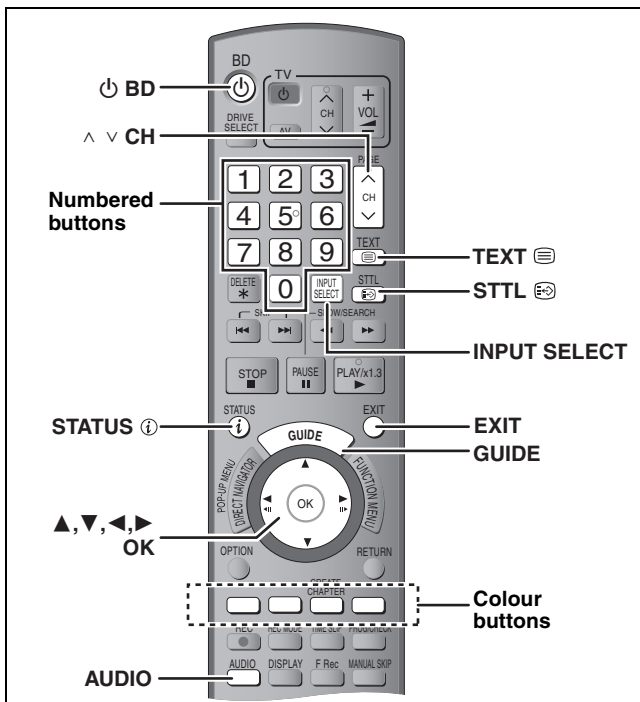

This unit has the tuner which allows it to directly receive and record digital terrestrial channels.

Important:

This unit does not have an analogue broadcast tuner.

Select the channel

- 1 Turn on the television and select the appropriate AV input to suit the connections to this unit.
- 2 Press [**BD**] to turn the unit on.
- 3 Press [**INPUT SELECT**] a few times and select "TV".

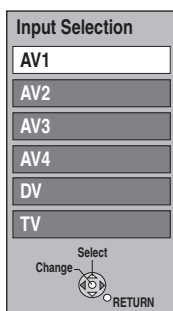

- It will switch when the display is turned off. (It will switch faster by pressing [OK])

- 4 Press [**CH**] to select the channel.

Everytime you change the station, digital channel information appears automatically. The length of time the digital channel information is displayed can be changed. (⇒ 86, On-Screen Messages)



- You can also select the channel with the numbered buttons.
e.g., 5: [0] ⇒ [0] ⇒ [5]
15: [0] ⇒ [1] ⇒ [5]
115: [1] ⇒ [1] ⇒ [5]

Note

- This unit can receive free cable television but it cannot receive paid services.

Select the programme to view using the TV Guide

- 1 Press [**GUIDE**].

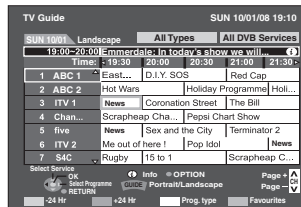

Operations in the TV Guide system (⇒ 37)

- 2 Press [**▲**, **▼**, **◀**, **▶**] to select the programme to view and press [**OK**].

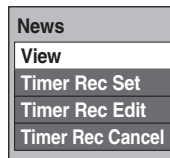

- This is displayed only when the programme currently broadcasting is selected.

- 3 Press [**▲**, **▼**] to select "View" and press [**OK**].

To exit the screen

Press [**EXIT**].

Switching audio of the TV broadcast

Press [**AUDIO**].

- Audio will switch according to the contents of the programme every time it is pressed.



To show subtitle

When "STTL" appears in digital channel information (⇒ 21)

Press [**STTL**].

- Press again to hide the subtitle.

To show Teletext

You can enjoy teletext broadcasting, including news, weather forecasts and subtitles, if this service is provided by the broadcasters.

When "TEXT" appears in digital channel information (➡ right)

1 Press [TEXT].

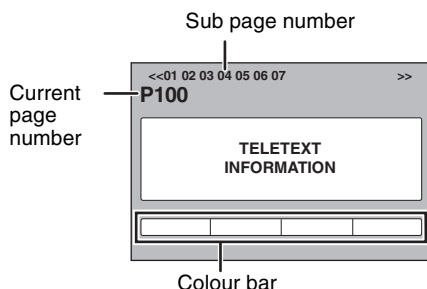

2 Press [▲, ▼], the numbered buttons, or the colour buttons to select the page.

Follow the instruction on the screen to select the page.

To show the sub page
(Only when there are sub pages)
Press [◀, ▶].

Change the Teletext mode

"Teletext" of the Setup menu can be changed to following modes. (➡ 86)

- **TOP mode** (Only when there is TOP text)
TOP is a particular improvement of the standard teletext service that results in an easier search and effective guide.
 - Fast overview of the teletext information available
 - Easy to use step-by-step selection of the topical subject
 - Page status information at the bottom of the screen
- **List mode**
Four differently coloured page numbers are situated at the bottom of the screen. Each of these numbers can be altered and stored in this unit.

To store frequently viewed page (List mode only)

- During the page is displayed
- ① Press the colour button of the colour to store.
 - ② Press and hold [OK].

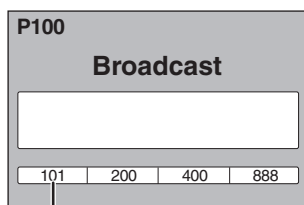

The number changes to white.

To change stored pages (List mode only)

- ① Press the colour button of the colour to change.
- ② Enter the new page number with the numbered buttons.
- ③ Press and hold [OK].

To exit the teletext screen

Press [TEXT].

Note

- The teletext function depends on respective stations.

Digital channel information

While stopped

Press [STATUS].

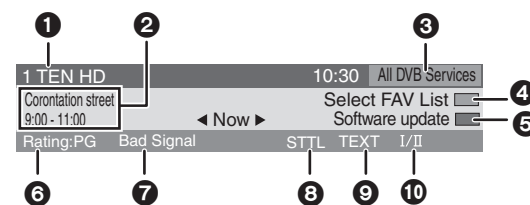

- ① Channel and Station Name
- ② Programme name and Broadcast time
- ③ Current favourite list
- ④ Change the favourite list
- ⑤ Software update (➡ 93)
- ⑥ The parental ratings level is displayed
- ⑦ TV signal is weak (➡ below)
- ⑧ Subtitle (➡ 20)
- ⑨ Teletext (➡ left)
- ⑩ Multiple audio

To switch information of the current programme and the next programme

Press [◀, ▶].

To show detailed information about the programme

Press [STATUS] again.

To hide the information screen

Press [STATUS] once or twice.

If "Bad Signal" is displayed:

- Adjust the position and direction of the aerial.
- Check that the current digital broadcast channel is correctly broadcasting.

Note

You can also select the other channel when the information screen is displayed by pressing [▲, ▼] and [OK].

If New service message appears

(➡ 83, New Service Message)

Refer to “Advanced playback” (⇒ 38) for detail information.

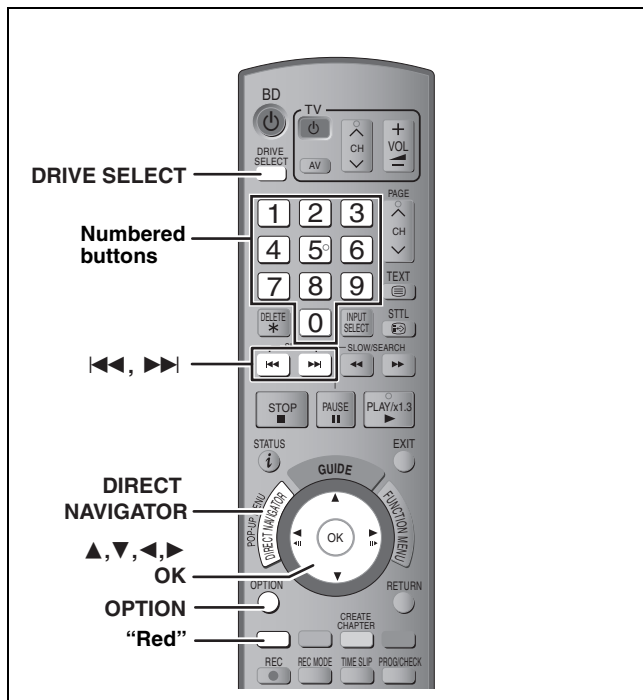

Preparation

- Turn on the television and select the appropriate video input to suit the connections to this unit.
- Turn on this unit.

Playing BD-Video or DVD-Video

- 1 Press [**▲ OPEN/CLOSE**] on the main unit to open the tray and insert a disc.
 - Press the button again to close the tray.
 - Play starts from the point specified by the disc.
- 2 When a menu screen appears on the television Press [**▲, ▼, ◀, ▶**] to select the item and press [**OK**].

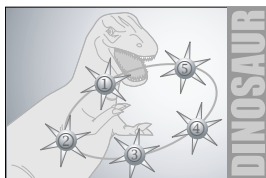

- Some items can also be selected using the numbered buttons.
- If you are instructed to press the “ENTER” button by the menu screen or the disc’s instruction document, press [**OK**].

To return to the menu screen

BD-V

While playing

- 1 Press [**OPTION**].
- 2 Press [**▲, ▼**] to select “Top Menu” and press [**OK**].

While stopped

Press [**DIRECT NAVIGATOR**].

DVD-V

- 1 Press [**OPTION**].
 - 2 Press [**▲, ▼**] to select “Top Menu” and press [**OK**].
- You can also press [**DIRECT NAVIGATOR**] to return to the menu screen.

Note

- **BD-V** You cannot playback while recording in recording mode other than DR mode. Also, it will stop the playback when the timer recording starts during the playback.

Playing recorded video contents

HDD BD-RE BD-R RAM -R -R DL -RW(V) +R +R DL +RW -RW(VR)

You can quickly find the recorded titles and easily play them. You can also sort the titles or edit the Groups of titles.

Following screen is displayed when recordable disc is inserted.

e.g.,

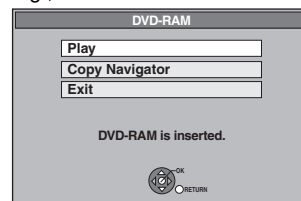

Press [**▲, ▼**] to select “Play” and press [**OK**]. It will go to step 3 (⇒ below).

- 1 Press [**DRIVE SELECT**] to select the HDD or BD drive.

The HDD or BD indicator lights up on the unit’s display.

- 2 Press [**DIRECT NAVIGATOR**].

HDD BD-RE RAM When “VIDEO” is not selected, press the “Red” button to select “VIDEO”.

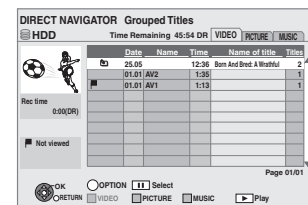

- 3 Press [**▲, ▼**] to select the title and press [**OK**].

To show other pages

Press [**◀, ▶**].

Regarding **DIRECT NAVIGATOR** (⇒ 40)

To exit the screen

Press [**DIRECT NAVIGATOR**].

Refer to “Important notes for recording” (⇒ 28) and “Advanced recording” (⇒ 30) for detail information.

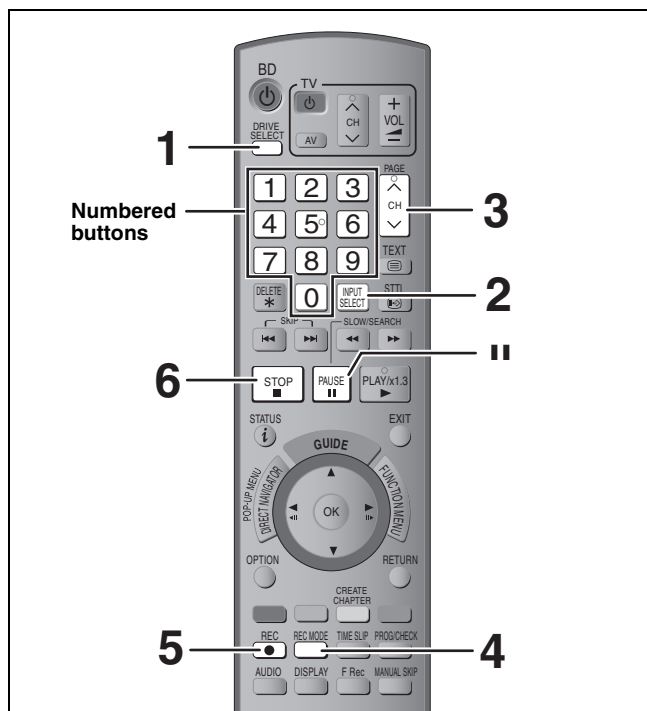

This operation will only record to HDD.
To record to a disc (⇒ 25)

Preparation

- Turn on the television and select the appropriate video input to suit the connections to this unit.
- Turn on this unit.

1 Press [DRIVE SELECT] to select the HDD drive.

The HDD indicator lights up on the unit's display.

2 Press [INPUT SELECT] a few times and select “TV”.

3 Press [▲ ▼ CH] to select the channel.

To select with the numbered buttons:

e.g., 5: [0] → [0] → [5]
15: [0] → [1] → [5]
115: [1] → [1] → [5]

4 Press [REC MODE] to select the recording mode.

- It will switch every time it is pressed.

e.g.,

Recording Mode	
Remain in DR mode	45:53
Remain in XP mode	115:02
Remain in SP mode	230:02
Remain in LP mode	460:53
Remain in EP mode	917:51

It can be recorded with the same quality of the broadcast.

- It will switch when the display is turned off. (It will switch faster by pressing [OK])
- Recording modes (⇒ 30)
- To record 2 programmes simultaneously (⇒ 31)

5 Press [● REC] to start recording.

“REC1” or “REC2” will light

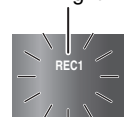

Recording will take place on open space on the HDD. Data will not be overwritten.

- Recording mode cannot be changed while recording a programme.
- When [● REC] is pressed while a drive other than the HDD is selected, it will automatically switch to HDD and start the recording.

6 To stop recording Press [■].

■ To pause recording

Press [II].

Press again to restart recording.

You can also press [● REC] to restart.

(Title is not split into separate titles.)

When recording digital broadcast with subtitle or multiple audio

If a programme to record has subtitle or multiple audio, there are following differences depending on the recording modes.

- **When recording in DR mode**
All subtitles and multiple audio are recorded. It is possible to switch them after recording.
- **When recording in XP, SP, LP, or EP modes**
Subtitles cannot be recorded. Multiple audio will be recorded with the contents selected when the recording starts, and the switching cannot be done after the recording.
Select the audio to be recorded with “Audio Mode for Digital Broadcast” in the Setup menu prior to the recording. (⇒ 86)

To specify a time to stop recording—One Touch Recording

During recording

Press [● REC] on the main unit to select the recording time.

- You can specify up to 4 hours later.
- The unit display changes as shown below.
OFF 0:30 → OFF 1:00 → OFF 1:30 → OFF 2:00
Counter (cancel) ← OFF 4:00 ← OFF 3:00 ←

- This does not work during timer recordings (⇒ 24, 34) or while using Flexible Recording (⇒ 32).
- The unit turns off automatically after the time to stop recording is reached.

To cancel

Press [● REC] on the main unit several times until the counter appears.

- The time to stop recording is cancelled; however, recording continues.

To stop recording

Press [■].

Refer to “Advanced timer recording” (⇒ 34–37) for detail information.

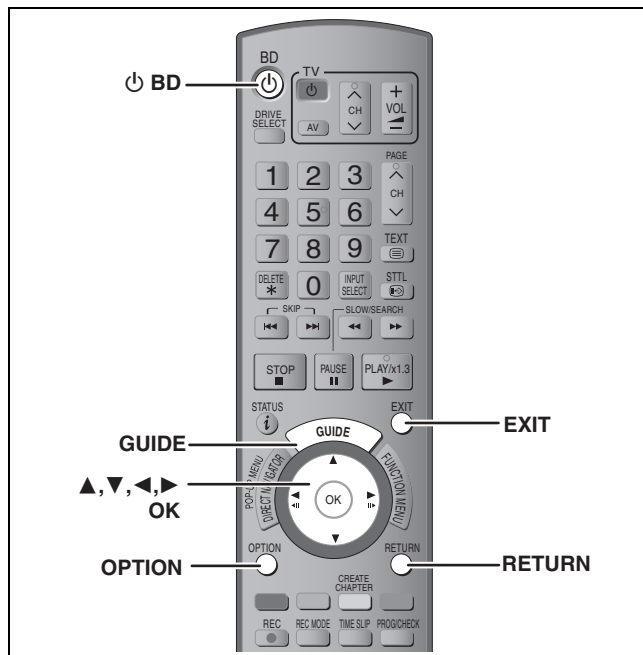

See also “Important notes for recording” (⇒ 28).
Depending on the type of disc used for recording or the type of broadcast, there may be restrictions on the title you are trying to record.

HDD BD-RE BD-R RAM

- You can enter up to 32 programmes up to a month in advance. (Each daily or weekly programme is counted as one programme.)

Preparation

- Turn on the television and select the appropriate video input to suit the connections to this unit.
- Turn on this unit.
- Make sure that the clock settings are correct (⇒ 89).

TV Guide system provides programme information only from the digital broadcasts station displayed on the television like a TV programme magazine.

Note

- TV Guide does not work if the clock is not set correctly.
- If “NTSC” has been selected for “TV System” (⇒ 87), the TV Guide system cannot be used.
- The receipt of the TV Guide system data is only possible via the aerial input of this unit. The receipt of the TV Guide data via externally connected satellite receivers is not possible.

Programme to HDD

1 Press [GUIDE].

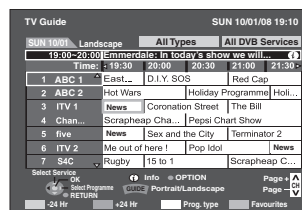

2 Press [▲, ▼, ◀, ▶] to select the future programme and press [OK].

- Following screen is displayed when the programme currently broadcasting is selected.

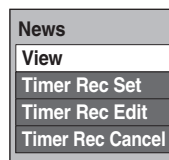

Press [▲, ▼] to select “Timer Rec Set” and press [OK].

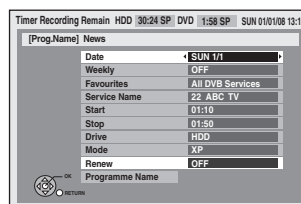

- Confirm the programme (start and end time) by using a TV magazine, etc. and make corrections if necessary using [▲, ▼, ◀, ▶] (⇒ 34, step 3).

3 Press [OK].

The timer programme is stored and the timer icon is displayed.



“⌚” lights on the unit’s display to indicate timer recording standby has been activated.
Press [⏻ BD] to turn the unit off.

To return to the previous screen

Press [RETURN].

To exit the screen

Press [EXIT].

Programme to a disc

BD-RE **BD-R** **RAM**

• Only 1 programme can be set to timer record on the disc.

1 Insert a disc.

■ When the screen with “Format Disc” is displayed

You need to format the unrecorded disc such as new discs.

e.g.,

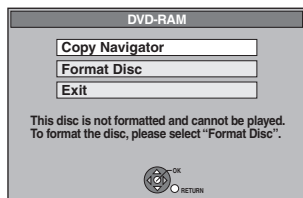

- ① Press [**▲**, **▼**] to select “Format Disc” and press [OK].
- ② Press [**◀**, **▶**] to select “Yes” and press [OK].
- ③ Press [**◀**, **▶**] to select “Start” and press [OK].

■ When the screen without “Format Disc” is displayed

The disc is already formatted.

Press [**▲**, **▼**] to select “Exit” and press [OK].

2 Press [GUIDE].

3 Press [**▲**, **▼**, **◀**, **▶**] to select the future programme and press [OK].

• Press [**▲**, **▼**] to select “Timer Rec Set” and press [OK] if the programme currently broadcasting is selected.

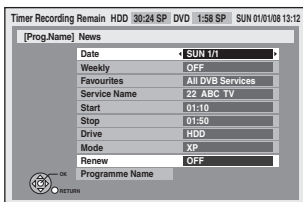

• Confirm the programme (start and end time) by using a TV magazine, etc. and make corrections if necessary using [**▲**, **▼**, **◀**, **▶**] (⇒ 34, step 3).

4 Press [**▲**, **▼**] to select “Drive” and press [**◀**, **▶**] to select “BD”.

5 Press [**▲**, **▼**] to select “Mode” and change the recording mode with [**◀**, **▶**].

• Modes that can be selected are different depending on the disc.

BD-RE **BD-R** :All recording mode

RAM :XP, SP, LP, EP, and FR

6 Press [OK].

The timer programme is stored and the timer icon is displayed.



“⌚” lights on the unit’s display to indicate timer recording standby has been activated.

Press [**⏻** BD] to turn the unit off.

■ To cancel a timer recording on the TV Guide screen

- ① Press [**▲**, **▼**, **◀**, **▶**] to select the programme in the TV Guide and press [OK].
- ② Press [**◀**, **▶**] to select “Yes” and press [OK]. (“⌚” in the TV Guide disappears.)

■ To modify the timer recording on the TV Guide screen

- ① Press [**▲**, **▼**, **◀**, **▶**] to select the programme in the TV Guide and press [OPTION].

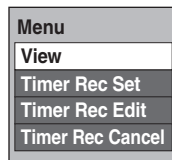

- ② Press [**▲**, **▼**] to select “Timer Rec Edit” and press [OK]. (⇒ 34, step 3)

■ To release the unit from recording standby (⇒ 35)

■ To cancel recording when recording has already begun (⇒ 35)

■ Notes on timer recording (⇒ 36)

To return to the previous screen

Press [RETURN].

To exit the screen

Press [EXIT].

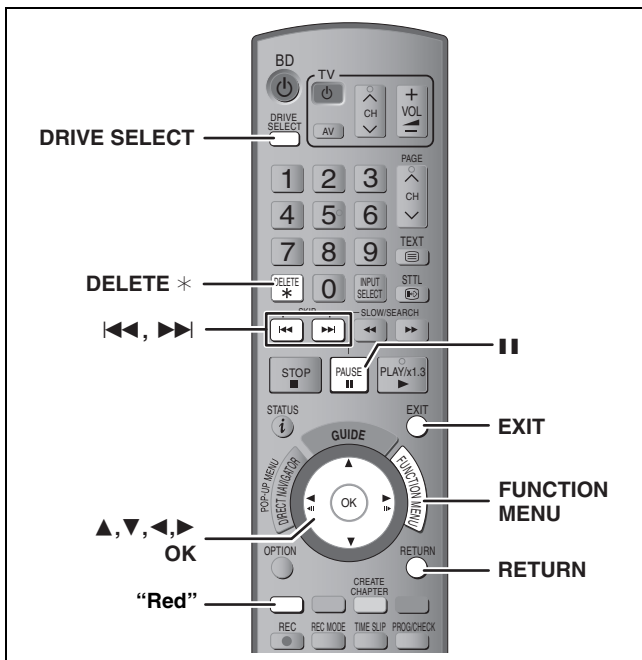

HDD BD-RE BD-R RAM -R -R DL -RW(V) +R +R DL +RW
 (You cannot delete items on finalised discs.)

- A title cannot be restored once it is deleted. Make certain before proceeding.
- Title that is currently recording cannot be deleted.
- Titles on the disc cannot be deleted in the following cases:
 - While recording to disc
 - While high speed copying

Preparation

- Press [DRIVE SELECT] to select the HDD or BD drive.
- **BD-RE BD-R RAM** Release protection (→ 79, Setting the protection).

Available disc space after deleting

- **HDD BD-RE RAM** The space deleted becomes available for recording.

Available disc space increases after deleting any of these titles

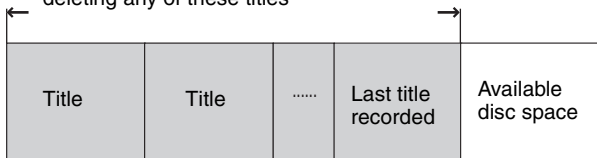

- **-RW(V) +RW** Available recording space increases only when the last recorded title is deleted.

Available disc space does not increase even after deleting



Later recorded titles

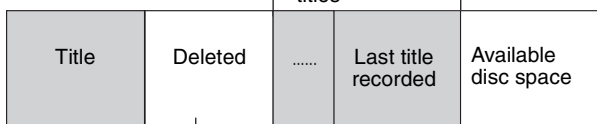

This space become available for recording after all the later recorded titles are deleted.

- **BD-R -R -R DL +R +R DL** Available space does not increase even after the contents are deleted.

Using the DELETE Navigator to delete

- 1 While stopped
Press [FUNCTION MENU].
- 2 Press [▲, ▼] to select “Delete” and press [OK].

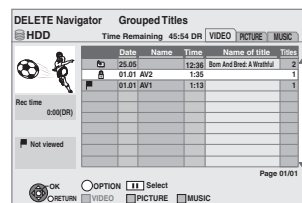

HDD BD-RE RAM When “VIDEO” is not selected, press the “Red” button to select “VIDEO”.

- 3 Press [▲, ▼] to select the title and press [III].

A check mark is displayed. Repeat this step until you select all necessary items.

- Press [III] again to cancel.

To show other pages
Press [◀, ▶].

Switching of the Navigator (→ 40)

You can confirm the titles, that you have selected using the option menu. (→ 44, step 4)

- 4 Press [OK].
- 5 Press [◀, ▶] to select “Delete” and press [OK].
The title is deleted.

To return to the previous screen
Press [RETURN].

To exit the screen
Press [EXIT].

Deleting during play

- 1 While playing
Press [DELETE *].
- 2 Press [◀, ▶] to select “Delete” and press [OK].
The title is deleted.

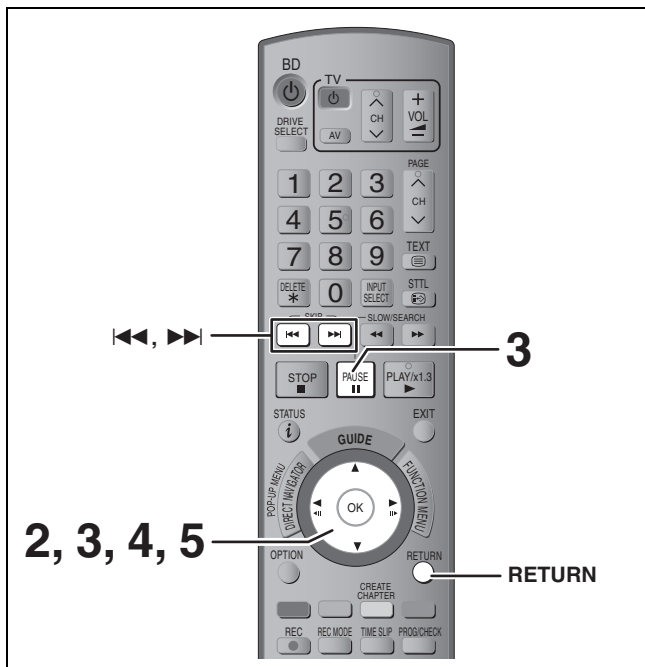

HDD → **BD-RE** **BD-R** **RAM** **-R** **-R DL** **-RW(V)** **+R** **+R DL** **+RW**
 (You cannot copy to finalised discs.)

DVD-R, DVD-R DL, DVD-RW (DVD-Video format), +R and +R DL are automatically finalised (⇒ 81). After finalising, the discs become play-only and you can also play them on other DVD equipment. However, you can no longer record or edit.

1 Insert a disc.

e.g.,

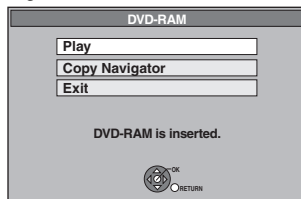

2 Press [▲, ▼] to select “Copy Navigator” and press [OK].

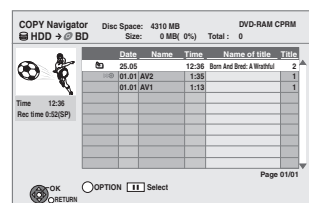

• Confirm that there is enough remaining disc space.

3 Press [▲, ▼] to select the title you want to copy and press [OK].

A check mark is displayed. Repeat this step until you select all necessary items.

• Press [OK] again to cancel.

To show other pages

Press [◀, ▶].

Switching of the Navigator (⇒ 40)

4 Press [OK].

5 Press [◀, ▶] to select “Start” and press [OK].

It will automatically format the unformatted disc, such as new disc, when copying.

To return to the previous screen

Press [RETURN].

To stop copying

Press and hold [RETURN] for 3 seconds.
 (You cannot stop while finalising)

■ COPY Navigator/Copying list icons and functions (⇒ 53)

■ To check the properties of a title and sort COPY Navigator/Copying list (⇒ 53)

■ Speed and recording mode when copying

For titles in DR mode

- **BD-RE** **BD-R**
 – High speed (recording mode as is)
- **RAM** **-R** **-R DL** **-RW(V)** **+R** **+R DL** **+RW**
 – Normal speed (FR mode)

For titles in XP, SP, LP, EP, or FR modes



- **BD-RE** **BD-R**
 – Normal speed (FR mode)
- **RAM**
 – High speed (recording mode as is)
 [When the copy destination (disc) does not have enough space, copy will perform at normal speed.]
- **-R** **-R DL** **-RW(V)** **+R** **+R DL** **+RW**
 Titles recorded with the “Rec for High Speed Copy” settings
 “On”: High speed (recording mode as is)
 “Off”: Normal speed (FR mode)



In the following cases, even if “Rec for High Speed Copy” is set to “On”, copy will perform at normal speed.

- **+R** **+R DL** **+RW** When the copying source was recorded in “EP” or “FR (recordings 5 hours or longer)” mode.
- When the copy destination (disc) does not have enough space.
- When the title aspect for the copying source and “Aspect for Recording” do not match.
- When the title aspect for the copying source is 16:9:
 – **+R** **+R DL** **+RW**
 – **-R** **-R DL** **-RW(V)** copying source was recorded in “EP” or “FR (recordings 5 hours or longer)” mode.

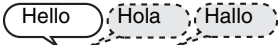
Note

- Titles in the grouped titles and other titles cannot be registered simultaneously.
- If you register multiple titles, they are copied in order from the title at the top of the screen and not in the order you registered them. To change the order that titles are copied, create a copying list and then copy the contents of the list (⇒ 52).
- Titles recorded using a different encoding system (PAL or NTSC) from the TV system currently selected on the unit cannot be copied.

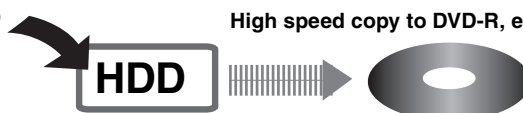
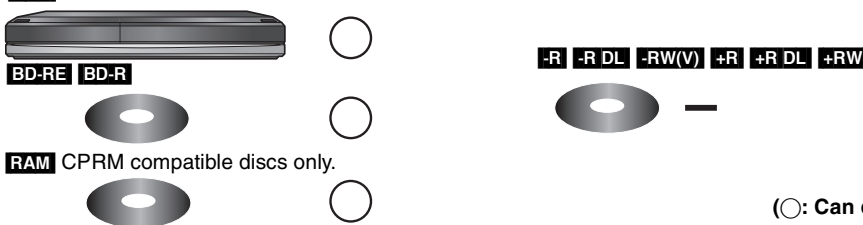
Regarding Recording to the disc	<p>You cannot record by pressing [● REC].</p> <ul style="list-style-type: none"> ● BD-RE BD-R RAM Timer recording is possible.
Selecting Audio for Recording	<p>Broadcast in multi-channel sound (Digital broadcast only): You can select the audio language when receiving audio in multi channel broadcast ["I/II" appears at the bottom of digital channel information display (⇒ 21)].</p> <ul style="list-style-type: none"> ● When recording in DR mode HDD BD-RE BD-R All multiple audio are recorded. It is possible to switch the audio after recording. ● When recording in XP, SP, LP, EP, or FR modes It will be recorded with the audio selected when the recording starts, and the switching cannot be done after the recording. Perform following operation before recording. <div style="text-align: center;">  </div> <div style="display: flex; align-items: center;">  <p>Select the audio that you want to record in "Audio Mode for Digital Broadcast" in the Setup menu (⇒ 86).</p> </div> <hr/> <p>Bilingual broadcasts (AV1, AV2, AV3, AV4 only): If you record from external equipment – Select "M 1" or "M 2" on the external equipment.</p>
Recording of the subtitles	<p>Programmes with subtitles (Digital broadcast only): It is possible to display the subtitles when you are receiving a programme with the subtitles. ["STTL" appears at the bottom of digital channel information display (⇒ 21)]</p> <ul style="list-style-type: none"> ● When recording in DR mode HDD BD-RE BD-R Subtitles will be recorded as is. It is possible to switch the subtitles after it is recorded. ● When recording in XP, SP, LP, EP, or FR modes Subtitles cannot be recorded.
Recording of 16:9 image such as wide broadcasting	<ul style="list-style-type: none"> ● When the "Rec for High Speed Copy" of the Setup menu is "On" <ul style="list-style-type: none"> – Record in XP, SP, LP, EP, or FR modes – Copy from the finalised disc (DVD-Video) to the HDD ● When recording to -R -R DL -RW(V) <div style="text-align: center; margin: 10px 0;">  </div> <p>It will be recorded in accordance to the setting of "Aspect for Recording" (⇒ 84) in the Setup menu.</p> <ul style="list-style-type: none"> ● In the following cases, even when set to "Automatic" or "16:9", recordings will be made or copied in 4:3. <ul style="list-style-type: none"> – -R -R DL -RW(V) When the recording mode is set to "EP" or "FR (recordings 5 hours or longer)" mode. – When recording to a +R, +R DL and +RW.
Recording and copy from the external equipment	<p>When recording from the external equipment connected to the AV1, AV2, AV3, or AV4 input terminals:</p> <ul style="list-style-type: none"> ● With the copyright specification, "One time only recording" programmes cannot be directly recorded or copied to BD-RE BD-R. It is recommended to use Panasonic DVD-RAM.
Recording of the high definition quality or surround audio	<p>Contents that can be recorded depends on the recording mode. (⇒ 30)</p> <ul style="list-style-type: none"> ● It is recorded in quality as broadcasted when the recording mode is DR.

<p>When you want to copy titles in high speed mode from the HDD to discs.</p>	<p>BD-RE BD-R</p> <ul style="list-style-type: none"> • Titles in DR mode can be copied at high speed. <p>RAM</p> <ul style="list-style-type: none"> • Titles in XP, SP, LP, EP, or FR mode can be copied at high speed. <p>-R -R DL -RW(V) +R +R DL +RW</p> <ul style="list-style-type: none"> • Titles in XP, SP, LP, EP, or FR mode can be copied at high speed using following method. Set "Rec for High Speed Copy" to "On" before recording to the HDD. (The default setting is "On". ➔ 84) <p style="text-align: center;"> Record to the HDD  High speed copy to DVD-R, etc. </p> <p>In the following cases, high speed mode does not work.</p> <ul style="list-style-type: none"> • +R +R DL +RW Titles recorded in "EP" mode and "FR (recordings 5 hours or longer)" mode • +R +R DL +RW Titles recorded in 16:9 aspect • -R -R DL -RW(V) Titles recorded in 16:9 aspect using "EP" mode or "FR" (recordings 5 hours or longer) mode
<p>When recording the "One time only recording" broadcasts</p>	<p>Use the HDD, BD-RE, BD-R or CPRM (➔ 114) compatible DVD-RAM.</p> <p>HDD</p>  <p>BD-RE BD-R -R -R DL -RW(V) +R +R DL +RW</p> <p>RAM CPRM compatible discs only.</p> <p style="text-align: right;">(○: Can do, -: Cannot do)</p> <ul style="list-style-type: none"> • "One time only recording" titles can only be transferred from the HDD to a disc (They are deleted from the HDD). They cannot be copied. • Even when copying to videotape the title may not be copied correctly because of the copy guard.
<p>Playing the disc on other players</p>	<p>-R -R DL -RW(V) +R +R DL</p> <p>The disc must be finalised (➔ 81).</p> <p>It is necessary to finalise DVD-R, etc. on this unit after recording or copying titles to them. You can then play them as a commercially sold DVD-Video. However, the discs become play-only and you can no longer record or copy.*</p> <p>* You can record and copy again if you format DVD-RW.</p> <p style="text-align: center;">  </p> <p>+RW If the disc failed to play on other equipment, we recommend you create top menu (➔ 81).</p>

Recording modes

This also explains about while recording and while copying. (There are discs that can only copy, depending on the disc)

Recording mode	DR	XP, SP, LP, EP	FR
Disc that can be recorded	HDD BD-RE BD-R	HDD BD-RE BD-R RAM -R -R DL -RW(V) +R +R DL +RW	
Features	Direct Recording mode Record with the same quality of the broadcast	Record in quality as in conventional analogue broadcast	Flexible Recording Mode Record by automatically adjusting the quality between XP, SP, LP, and EP depending on the remaining area on the disc
Broadcasting/input that can be recorded	Digital broadcasting	Digital broadcasting External input DV input	
Quality that can be recorded	Quality same as broadcasted (HD quality and SD quality)	SD quality only	
The audio of the surround programme	Surround audio as the broadcast	Stereo audio	
Multiple audio	Record all multiple audio	Record only one audio <ul style="list-style-type: none"> ● Before recording <ul style="list-style-type: none"> – Select the audio with “Audio Mode for Digital Broadcast” in the Setup menu (⇒ 86). ● Before copying <ul style="list-style-type: none"> – “Copy”, “Advanced Copy”: Select the audio with “Audio Mode for Digital Broadcast” in the Setup menu (⇒ 86). – “Copy Title Playing”: Select the audio with “Multi Audio” in the Disc menu (⇒ 76). 	
Subtitles	Can be recorded	Cannot be recorded	

■ Recording modes and approximate recording times

Depending on the content being recorded, the recording times may become shorter than indicated. (The times provided on this chart are an estimate.)

Recording Mode	HDD (500 GB)	BD-RE BD-R (25 GB)	BD-RE DL BD-R DL (50 GB)	DVD-RAM		DVD-R DVD-RW +R +RW (4.7 GB)	DVD-R DL (8.5 GB)	+R DL (8.5 GB)
				Single-sided (4.7 GB)	Double-sided*2 (9.4 GB)			
DR*1 (HD:15 Mbps)	72 hours	3 hours 20 min.	6 hours 40 min.					
DR*1 (SD:8 Mbps)	135 hours	6 hours 30 min.	13 hours					
XP (High picture quality recording mode)	110 hours	5 hours 15 min.	10 hours 30 min.	1 hour	2 hours	1 hour	1 hour 45 min.	1 hour 45 min.
SP (Standard recording mode)	220 hours	10 hours 30 min.	21 hours	2 hours	4 hours	2 hours	3 hours 35 min.	3 hours 35 min.
LP (Long recording mode)	442 hours	21 hours	42 hours	4 hours	8 hours	4 hours	7 hours 10 min.	7 hours 10 min.
EP (Extra long recording mode)*3	885 hours (664 hours*4)	42 hours (31 hours 30 min.*4)	84 hours (63 hours*4)	8 hours (6 hours*4)	16 hours (12 hours*4)	8 hours (6 hours*4)	14 hours 20 min. (10 hours 45 min.*4)	14 hours 20 min. (10 hours 45 min.*4)

*1 Recording time of DR mode depends on bit rate of broadcasting.

*2 It is not possible to record or play continuously from one side of a double sided disc to the other.

*3 When recording to the HDD in “EP” or “FR (recordings 5 hours or longer)” mode, you cannot perform high-speed copy to +R, +R DL or +RW discs.

*4 When “Recording time in EP mode” is set to “6 hours” in the Setup menu (⇒ 84). The sound quality is better when using “6 hours” than when using “8 hours”.

● **RAM** When recording to DVD-RAM using “8 hours” mode, play may not be possible on DVD players that are compatible with DVD-RAM. Use “6 hours” mode if playback may be on other equipment.

■ Regarding recording time remaining

This unit records using a VBR (Variable bit rate) data compression system to vary recorded data segments to match video data segments which may cause differences in the displayed amount of time and space remaining for recording.

If the remaining amount of time is insufficient, delete any unwanted titles to create enough space before you start recording.

- Remaining time in the DR mode is calculated with a bit rate of 15 Mbps. But the bit rate differs depending on the broadcast, so the displayed remaining time might be different from the actual remaining time.

■ Maximum number of titles that can be recorded

- HDD**
- You can record up to 499 titles on HDD. (When continuously recording for long durations, titles are automatically divided every 8 hours.)

- BD-RE BD-R**
- You can record up to 200 titles on one disc.

- RAM -R -R DL -RW(V)**
- You can record up to 99 titles on one disc.

- +R +R DL +RW**
- You can record up to 49 titles on one disc.

■ FR (Flexible Recording Mode)

You can set FR (Flexible Recording) mode when copying or programming timer recordings.

The unit automatically selects a recording rate between XP and EP (8 hours) that will enable the recordings to fit in the remaining disc space with the best possible recording quality.



For example with a 90 minute recording to an unused DVD-RAM, the picture quality is adjusted to between “XP” and “SP”.



- When recording to the HDD, picture quality is automatically adjusted to precisely fit a copied title on a 4.7 GB disc.

2 programmes simultaneous recording

It is possible to record 2 programmes simultaneously.

Possible combination for 2 programmes simultaneous recording

<p>To record both programmes to the HDD</p>	 HDD Digital broadcast (DR mode)	and	 HDD Digital broadcast or external input
---	---	-----	--

<p>To record 1 programme each onto the HDD and the disc</p>	 HDD Digital broadcast (DR mode)	and	 BD-RE BD-R DVD-RAM (When timer recording) Digital broadcast or external input
---	---	-----	---

To perform 2 programmes simultaneous recording, 1 programme out of the 2 needs to be recorded to the HDD in “DR” mode.

Note

- 2 programmes simultaneous recording is not possible in following conditions:
 - 2 programmes from the external input
 - While recording from DV input, or executing “Recording via AV3 input”
 - While high speed copying
 - 2 programmes on same channel cannot be recorded simultaneously by pressing [● REC].

Flexible Recording

(Recording that fits the remaining disc space)

HDD

Recorded title is recorded exactly to the size of the new disc (4.7 GB) by automatically selecting optimal quality from “XP”, “SP”, “LP”, or “EP”.

Preparation

- Select the channel or the external input to record.
- Press [DRIVE SELECT] to select the HDD drive.

- 1 While stopped
Press [F Rec].

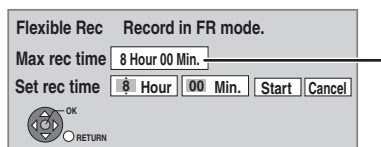

Maximum recording time
This is the maximum recording time in EP (8 hours) mode.

- 2 Press [◀, ▶] to select “Hour” and “Min.” and press [▲, ▼] to set the recording time.
 - You can also set the recording time with the numbered buttons.
 - You cannot record more than 8 hours.

- 3 When you want to start recording
Press [◀, ▶] to select “Start” and press [OK].
 - Recording starts.

To exit the screen without recording

Press [RETURN].

To stop recording partway

Press [■].

To show the remaining time

Press [STATUS ⓘ].



Playing while you are recording

Chasing playback

Playback from the beginning of the title of the programme recording to the HDD, while recording to the HDD.

Simultaneous rec and play

Playback the previously recorded title while recording onto the HDD or timer recording onto the disc.
However, disc cannot be played back while timer recording onto the disc.

- 1 Press [DRIVE SELECT] to select the HDD or BD drive.
- 2 Press [DIRECT NAVIGATOR] during recording.

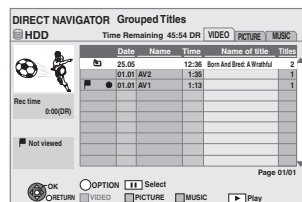

“●” is displayed on the recording programme.

- 3 Press [▲, ▼] to select a title and press [OK].

To stop play

Press [■].



To exit the Direct Navigator screen

Press [DIRECT NAVIGATOR].

Note

“Chasing playback” and “Simultaneous rec and play” can only be used with programmes of the same encoding system (PAL/NTSC).

Operation during Recording

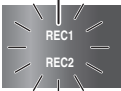
<p>Check the recording programme</p>	<p>Press [STATUS ⓘ].</p> <p>e.g., while 2 programmes simultaneous recording</p> <div style="display: flex; justify-content: space-between; align-items: flex-start;"> <div style="width: 60%;"> <p>Recording programme displayed on the TV screen</p>  </div> <div style="width: 35%;"> <p>Recording programme not displayed on the TV screen</p>  </div> </div>
<p>Display the recording programme on the TV screen</p>	<p>It is necessary to display the recording programme onto the TV screen to perform operations such as pause.</p> <ul style="list-style-type: none"> ● If the input was switched: Press [INPUT SELECT]. ● If the channel was switched: Press [^ v CH]. ● If the drive was switched: Press [DRIVE SELECT].
<p>To stop recording</p>	<p>It is necessary to display the programme you want to stop on the TV screen while 2 programmes simultaneous recording. (➡ above)</p> <p>Press [■].</p> <ul style="list-style-type: none"> ● From the start to the end of the recording is called one title.
<p>To pause recording</p>	<p>It is necessary to display the programme you want to pause on the TV screen. (➡ above)</p> <p>Press [].</p> <ul style="list-style-type: none"> ● Press again to restart recording. You can also press [● REC] to restart. (Title is not split into separate titles.) ● When the recording in DR mode is paused, that part will show up as still picture instantaneously while playback.
<p>Switch the input</p>	<p>Press [INPUT SELECT].</p>
<p>Switch to other channel</p>	<p>Press [^ v CH].</p>
<p>Perform 2 programmes simultaneous recording</p>	<p>Record other programme with steps 1–5 on page 23.</p> <ul style="list-style-type: none"> ● One of the 2 programmes needs to be digital broadcasting recorded with DR mode. <p style="text-align: right;">“REC1” and “REC2” will light</p> <div style="text-align: center;">  </div> <ul style="list-style-type: none"> ● Channel switch / input switch while performing 2 programme simultaneous recording will switch between the 2 recording programmes.

Manually programming timer recordings

HDD BD-RE BD-R RAM

1 Press [PROG/CHECK].

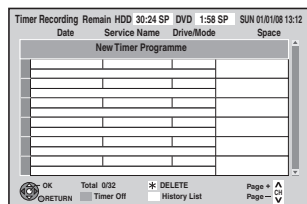

2 Press [▲, ▼] to select “New Timer Programme” and press [OK].

3 Press [▲, ▼] to select the items and change the items with [◀, ▶].

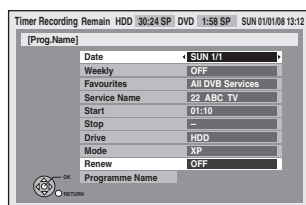

- **Date**
Current date up to one month later minus one day
- **Weekly**
Titles recorded using the same daily or weekly timer are bundled and displayed as a “group” in the Direct Navigator screen (⇒ 40) except when using Auto Renewal Recording.
- **Favourites**
Select the favourites list
Select “AV input” when recording from the external input.
- **Service Name**
Select the channel to record.
“AV1”, “AV2”, “AV3”, or “AV4” can be selected when “AV input” is selected in “Favourites”.
- **Start/Stop**
Press and hold [◀, ▶] to alter the Start (Start time) and Stop (Finish time) in 15-minute increments.
- **Drive**
Only 1 programme can be set to timer record on the disc.
When the recording drive is “BD” and there is not enough remaining space, recording automatically switches to the “HDD” (⇒ 35, Relief Recording).
- **Mode**
Recording modes (⇒ 30)
- **Renew (Auto Renewal Recording)** (⇒ 35)
- **Programme Name**
Press [OK]. (⇒ 73, Entering text)

4 Press [OK].

The timer programme is stored and the timer icon is displayed.

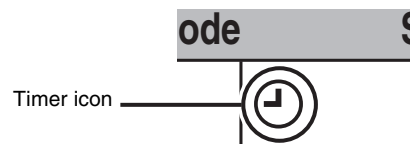

“Ⓞ” lights on the unit’s display to indicate timer recording standby has been activated.

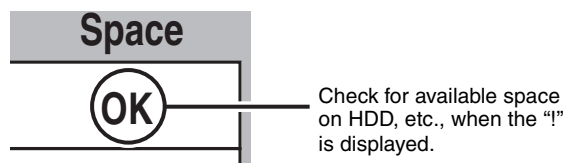

Press [⏻ BD] to turn the unit off.

To return to the previous screen

Press [RETURN].

To exit the screen

Press [EXIT].

To release the unit from recording standby

Even when the unit is turned off, you can display the timer recording list by pressing [PROG/CHECK].

- 1 Press [PROG/CHECK].
- 2 Press [▲, ▼] to select the programme and press the “Red” button.
 - The timer icon “⊙” (⇒ 36) will change to grey.
 - You cannot cancel timer recording standby mode as long as even one timer icon “⊙” (red) remains in the timer recording list.
 - Press the “Red” button again to activate timer recording standby. (The timer icon “⊙” will change to red.)

Relief Recording

When the recording drive is “BD” and there is not enough remaining space, recording automatically switches to the “HDD”. If there is no disc in the tray or the disc cannot be recorded on or when timer recording starts while copying, etc., the recording drive will be altered to the HDD.

- The Direct Navigator shows which programmes were relief-recorded (“▶” is displayed.) (⇒ 40).
- If the time remaining on the HDD is insufficient, as much of the programme as possible will be recorded onto the HDD.

Auto Renewal Recording

HDD

If you record a programme onto HDD repeatedly everyday or every week using timer recording, the unit will record the new programme over the old one.

This function can be used only when weekly recording or daily recording is selected.

- 1 Press [PROG/CHECK].
- 2 Press [▲, ▼] to select the programme and press [OK].
- 3 Press [▲, ▼] to select “Renew” column.
- 4 Press [◀, ▶] to select “ON” and press [OK].

Note

- If a programme set for Auto Renewal Recording is protected or while playback is taking place from the HDD, or while copying, the programme will not be overwritten. Instead the programme set for recording will be saved as a separate programme, and this programme will be the one to be overwritten when the next Auto Renewal Recording takes place.
- When there is not enough space on the HDD, the programme may not be recorded completely.

To cancel recording when recording has already begun

Press [INPUT SELECT] or [^ v CH] to display the programme that you want to stop recording on the TV screen while 2 programmes are simultaneously recording.

- 1 Press [■].
e.g.,

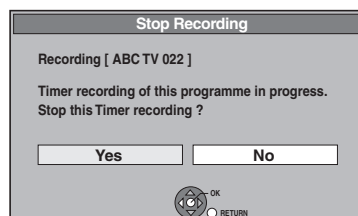

- 2 Press [◀, ▶] to select “Yes” and press [OK].

- If you stop a timer recording, it will be cancelled. However, if you have set a weekly, daily timer recording, the recording will start from the next time the timer recording is set.

Check, change or delete a programme

- Even when the unit is turned off, you can display the timer recording list by pressing [PROG/CHECK].

Press [PROG/CHECK].

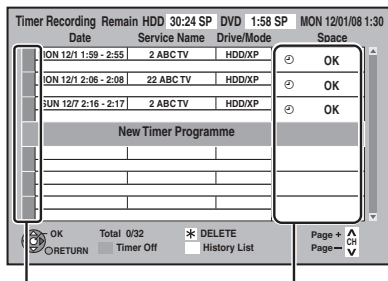

Icons

- ⊙ Red :Timer recording standby is activated.
Grey:Timer recording standby is not activated.
- This programme is currently recording.
- 🕒 Part or all of the programme will not be recorded since the programme is overlapping.
- 🗑️ The disc was full so the programme failed to record.
- 🔒 The programme was copy-protected so it was not recorded.
- ✉ The programme did not complete recording because the disc is dirty or some other reason.
- 🔄 Timer programmes set to Auto Renewal Recording (➔ 35).
- 📁 Timer programmes that will be relief recorded to the HDD.

OK: Displayed if the recording can fit in the remaining space.

→ **(Date):** For recordings made daily or weekly, the display will show until when recordings can be made (up to a maximum of one month from the present time) based on the time remaining on the disc.

- ! : It may not be possible to record because:
- there is not enough space left.
 - the number of possible titles has reached its maximum.

■ To change a programme

Press [▲, ▼] to select the programme and press [OK]. (➔ 34, step 3)

■ To delete a programme

Press [▲, ▼] to select the programme and press [DELETE *].

■ Confirm the History List

- 1 Press the "Green" button.
- 2 Press [▲, ▼] to select the programme and press [OK].
 - Reason why the timer recording failed or similar can be confirmed.
 - Press the "Green" button to return to the previous screen.

■ To exit the timer recording list

Press [PROG/CHECK].

Note

- Programmes that failed to record are deleted from the timer recording list at 4 a.m. two days later.

Notes on timer recording

- Only 1 programme can be set to timer record on the disc.
- Timer recording will not be performed if the clock is not set.
- If the "TV system" (➔ 87) in the Setup menu was modified to playback a disc or a title while on timer recording standby, return the setting to original before the recording is started.
- Timer recordings are activated regardless of whether the unit is turned on/off.
- Timer recordings begin when the set time is reached even when playing.
- If the unit is turned on when timer recording begins, it remains turned on after recording finishes. It does not turn off automatically. You can turn the unit off during timer recording.
- When you programme successive timer recordings to start immediately one after the other, last 1 minute of earlier programme will not be recorded unless it can perform 2 programmes simultaneous recording.

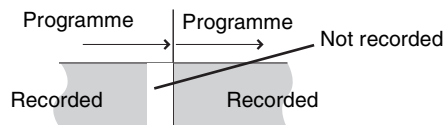

First 1 minute of the following programme is not recorded either if the following programme set to be recorded is also BD.

- If the start of 2 timer recordings overlap with each other when 2 programme simultaneous recording is not possible, the programme with the earlier start time will be recorded.

Starting of the timer recording while executing other operation ➔ 99

Operations in the TV Guide system

Basic operations

Press [GUIDE] to switch between Landscape view and Portrait view.

Landscape view

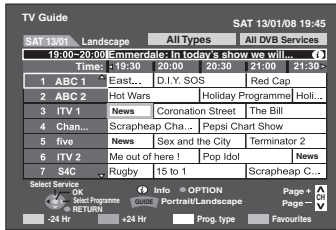

Portrait view

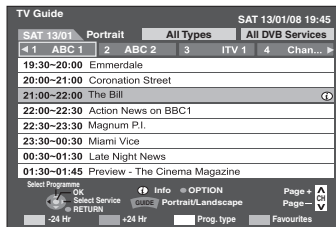

To change channels	<p>Landscape view Press [▲, ▼] to select a channel.</p> <p>Portrait view Press [◀, ▶] to select a channel. The TV Guide list appears for this channel.</p>
To view a programme list for another day	<ul style="list-style-type: none"> • Jump ahead 24 hours Press the “Green” button to jump ahead by one day. • Jump back 24 hours Press the “Red” button. You can only jump back to the current date. Past information cannot be viewed. <p>When jumping, the selected time period may deviate.</p>
To browse through the TV Guide list	<p>Press [^ v CH].</p>
To see programme information (Programmes with the ⓘ symbol)	<p>Press [STATUS ⓘ]. Additional information (programme name, programme duration, broadcast time, description) is available for these programmes. Press [▲, ▼] to scroll up and down. To show other pages Press [CH ^] (Previous) or [v CH] (Next). Press [STATUS ⓘ] again to return to the programme list.</p>

When the TV Guide displays the empty TV Guide list



The “empty” field

- Some digital broadcast may not send programme information. Set the timer recording manually (→ 34).

Selecting the programme from the desired programme type or favourites

This function lets you display a TV Guide list sorted by programme type (e.g. Movies, Sport) or favourites.

- From the desired programme type
Press the “Yellow” button to display the list of programme type.
From the desired favourites
Press the “Blue” button to display the list of favourites.
- Press [▲, ▼] to select the desired item.

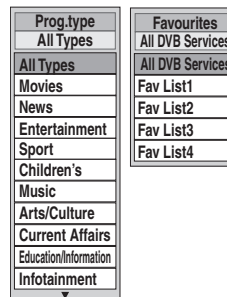

- Press [OK].

- A list appears with all programmes of the selected item.
- When you select the Landscape view, the unit displays programmes in grey that do not belong to the selected programme type.

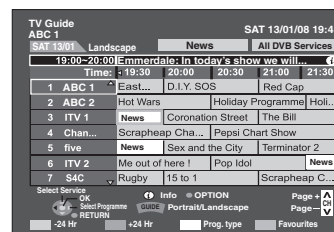

e.g., Programme type, “News” is selected in step 2 of Landscape view.

Note

The broadcasters allocate individual programmes to topic areas. This function does not work properly unless the information which distinguishes the programme type and groups sent from broadcast stations is correct.

- Press [▲, ▼, ◀, ▶] to select the programme.

To return to the previous TV Guide list before you have selected the programme type or favourites

Select “All Types” of the programme type or “All DVB Services” of the favourites in step 2 above.

To return to the previous screen
Press [RETURN].

To exit the screen
Press [EXIT].

TV Guide data download

- Download automatically while the unit is on.

Note

- When playing back a title recorded on the HDD, BD-RE or BD-R, ensure that you match the “TV System” setting to the recorded title (➔ 87).
- A disc or title with different “TV System” (➔ 87) may not be able to playback while recording or on standby for the timer recording. You will be able to playback by changing the “TV System” settings in that case, but to prevent failure of the timer recording, change back the settings before the recording starts.
- Depending on the disc, it may take time for the menu screen, pictures, sound, etc. to start.
- The producer of the disc can control how discs are played. So you may not always be able to control play as described in these operating instructions. Read the disc’s instructions carefully.
- Discs continue to rotate while menus are displayed. Press [■] when you have finished playback to protect the unit’s motor, your television screen and so on.

Operation during play

- Depending on the media, some operations may not be possible.

<p>Stop</p>	<p>Press [■]. The stopped position is memorized.</p> <p>Resume play function Press [▶] (PLAY) to restart from this position.</p> <ul style="list-style-type: none"> • BD-V On BD-Video discs including BD-J (➔ 114), the resume play function does not work. <p>Stopped position</p> <ul style="list-style-type: none"> • HDD : Stopped position for each title is memorized. • Discs: Only previous stopped position is memorized. The position is cleared if the tray is opened. • AVCHD (SD card): Only previous stopped position is memorized. The position is cleared if the unit is turned off.
<p>Pause</p>	<p>Press [⏸]. Press [⏸] again or [▶] (PLAY) to restart play.</p>
<p>Search</p>	<p>Press [◀◀] or [▶▶].</p> <ul style="list-style-type: none"> • The speed increases up to 5 steps. (+R +R DL +RW up to 3 steps) • Press [▶] (PLAY) to restart play. • Audio is heard during first level search forward. • BD-V Only primary video is played while performing this operation.
<p>Skip</p>	<p>During play or while paused, press [◀◀] or [▶▶]. Skip to the title or chapter you want to play.</p> <ul style="list-style-type: none"> • It will skip to the beginning of chapters (➔ 46) if the title contains chapters. • HDD It will not skip the title. But the title in the grouped titles during the “Grouped Playback” (➔ 40) will be skipped.
<p>Starting from a selected title</p> <p>BD-V DVD-V AVCHD</p>	<p>Press the numbered buttons. Play starts from the selected title or chapter.</p> <ul style="list-style-type: none"> • BD-V AVCHD Input a 3-digit number e.g., 5: [0] ➔ [0] ➔ [5] 15: [0] ➔ [1] ➔ [5] • DVD-V Input a 2-digit number e.g., 5: [0] ➔ [5] 15: [1] ➔ [5] • While stopped (the screen on the right is displayed on the television), the title is designated. While playing, the chapter is designated. 
<p>Quick View</p> <p>Except -RW(V) -RW(VR)</p>	<p>Press and hold [▶] (PLAY/×1.3). Play speed is quicker than normal.</p> <ul style="list-style-type: none"> • Press again to return to normal speed. • Image may not be played back smoothly in case of DR mode titles or BD-V AVCHD. • BD-V Only primary video is played while performing this operation.
<p>Slow-motion</p>	<p>While paused, press [◀◀] or [▶▶]. The speed increases up to 5 steps. (+R +R DL +RW up to 3 steps)</p> <ul style="list-style-type: none"> • Press [▶] (PLAY) to restart play. • BD-V AVCHD and title that has copied AVCHD Forward direction [▶▶] only. • The unit will pause if slow-motion play is continued for approximately 5 minutes (excluding BD-V DVD-V AVCHD). • BD-V Only primary video is played while performing this operation.
<p>Frame-by-frame</p>	<p>While paused, press [◀] (◀◀) or [▶] (▶▶). Each press shows the next frame.</p> <ul style="list-style-type: none"> • Press and hold to change in succession forward or backward. • Press [▶] (PLAY) to restart play. • BD-V AVCHD Forward direction [▶] (▶▶) only. • Frame-by-frame backward for titles that have copied the AVCHD will be in 10 frame units. • BD-V Only primary video is played while performing this operation.

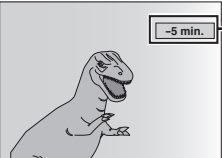
<p>Skipping the specified time (Time Slip) Except BD-V DVD-V AVCHD</p>	<p>1 Press [TIME SLIP]. 2 Press [▲, ▼] to select the time and press [OK]. Play skips the specified time. • Each time you press [▲, ▼], the time increases [▲] or decreases [▼] by 1 minute intervals. (Press and hold for 10-minute intervals.)</p>  <p>This automatically disappears after approximately 5 seconds. To show the screen again press [TIME SLIP] again.</p>
<p>Manual Skip Except BD-V DVD-V AVCHD</p>	<p>Press [MANUAL SKIP]. Each time you press, play restarts approximately 1 minute later.</p>
<p>Aspect</p>	<p>Switch the aspect ratio of the screen (➡ 77)</p>
<p>Create Chapter</p>	<p>Chapters are divided at the point pressed. (➡ 46)</p>

Changing audio during play

Press [AUDIO].

It will switch depending on the contents recorded every time it is pressed.

e.g., **HDD** "AudioL R" is selected.

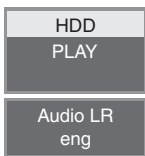

BD-V **DVD-V** **AVCHD**

You can change the audio channel number each time you press the button. This allows you to change things like the soundtrack language (➡ 76, Soundtrack).



e.g., English is selected.

Display the subtitle during play

It is possible to display the subtitles during the playback if the programme with subtitle is recorded with DR mode.

Press [STTL].

• It will switch between On/Off every time it is pressed.

BD-V **DVD-V** **AVCHD**

Display with "Subtitle" in the Disc menu (➡ 76, Subtitle).

When playing DVD-R DL (Dual Layer, single-sided) and +R DL (Double Layer, single-sided)

DVD-R DL (Dual Layer, single-sided) and +R DL (Double Layer, single-sided) discs have two writable layers on one side. If there is not enough space on the first layer to record a programme, the remainder is recorded on the second layer. When playing a title recorded on both layers, the unit automatically switches between layers and plays the title in the same way as a normal programme. However, video and audio may momentarily cut out when the unit is switching layers.

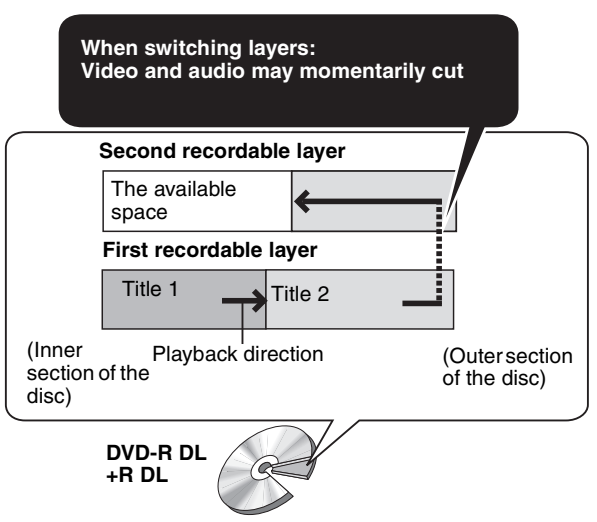

Direct Navigator screen icons

- Currently recording.
- 🔒 Title protected.
- 📄 Title that was not recorded due to recording protection
- ✕ Title cannot be played (When copying a title to the HDD, or when data is damaged etc.)
- ➡ Titles that have been rerouted to the HDD (➡ 35, Relief Recording)
- 📁 Title with “One time only recording” restriction (➡ 114, CPRM)
- 📁 Groups of titles (HDD only)
- 🚩 Title that was recorded but has not yet been played (HDD only)
- NTSC (NTSC) Title recorded using a different encoding system from that of the TV system currently selected on the unit.
- PAL (PAL) Title recorded using a different encoding system from that of the TV system currently selected on the unit.
 - Alter the “TV System” setting on this unit to suit (➡ 87).

Switching of the Navigator

“Grouped Titles”/“All Titles” HDD

It is possible to switch the screen display with the following operation even in the COPY Navigator or the DELETE Navigator screens.

- ① While the Navigator screen is displayed Press [OPTION].
- ② Press [▲, ▼] to select the item and press [OK].
e.g.,



“Grouped Titles” or “All Titles” HDD

Grouped Titles screen

Two or more titles recorded in the Daily/weekly timer recording mode are bundled and displayed as one item.

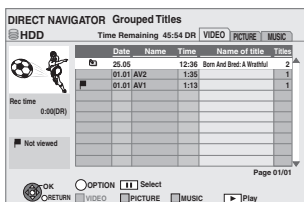

Select the item marked with and press [OK] to display the bundled titles.

All Titles screen

Displays all titles.

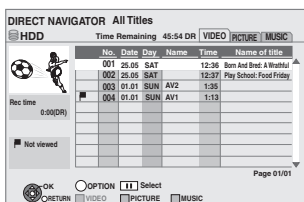

Playback the title that was viewed once HDD

You can choose to start the playback from the point you have last stopped, or from the beginning when the resume play function (➡ 38) is operating.

- ① While the Direct Navigator screen is displayed Press [OPTION].
- ② Press [▲, ▼] to select “Play” and press [OK].
- ③ Press [◀, ▶] to select “Last Played” or “Beginning” and press [OK].

To sort the titles for easy searching

HDD (All Titles screen only)

This function is convenient when searching for one title to playback from many titles.

- ① Press [OPTION].
 - ② Press [▲, ▼] to select “Sort” and press [OK].
 - ③ Press [▲, ▼] to select the item and press [OK].
- If you exit the Direct Navigator screen, the sort will be cancelled.

To play grouped titles HDD

HDD (Grouped Titles screen only)

Play the selected titles

- ① Press [▲, ▼] to select the group and press [OK].
- ② Press [▲, ▼] to select the title and press [OK].

Play the titles continuously (Grouped Playback)

While the Grouped Titles screen is displaying, Press [▲, ▼] to select the group and press [▶] (PLAY).

To edit the group of titles HDD

HDD (Grouped Titles screen only)

- ① Press [▲, ▼] to select a title or a group and press [■].
A check mark is displayed. Repeat this step until you select all necessary titles.
 - Press [■] again to cancel.
- ② Press [OPTION].
- ③ Press [▲, ▼] to select the option and press [OK].



Create Group:

Press [◀, ▶] to select “Create” and press [OK]. Selected titles are bundled to form a group.

Release Grouping:

Press [◀, ▶] to select “Release” and press [OK].
● All the titles in the group are released.

Remove:

(Only when titles in a group have been selected)
Press [◀, ▶] to select “Remove” and press [OK]. Selected titles are removed from the group.

Regarding the group name

The name of the first title in the group is used as the group name.

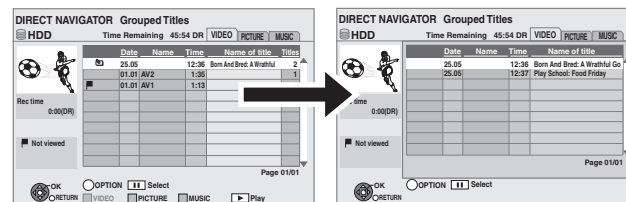

To change the group name

- 1 Press [▲, ▼] to select the group and press [OPTION].
 - 2 Press [▲, ▼] to select “Edit” and press [OK].
 - 3 Press [▲, ▼] to select “Enter Name” and press [OK].
 - 4 Enter the name. (➡ 73, Entering text)
- Even if the group name is changed, the title names in the group will not be changed.

Playback of the High Definition Camera Video (AVCHD)

AVCHD

It is possible to playback the high definition (AVCHD format) video recorded on the Panasonic digital high definition video camera on the disc or SD card.

- 1 Insert a disc or SD card.
- 2 Press [**▲**, **▼**] to select “Play AVCHD” and press [**OK**].

e.g., **RAM**

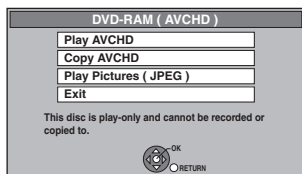

e.g., **SD**

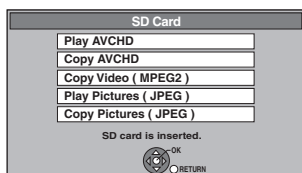

- If the top menu of the disc or SD card to play is
 - Created: Display the top menu
 - Not created: Display the “Direct Navigator” screen*
- * It may not be able to display the “Direct Navigator” screen depending on the equipment used to record.

- 3 Press [**▲**, **▼**, **◀**, **▶**] to select the title and press [**OK**].

e.g., **SD** Direct Navigator screen

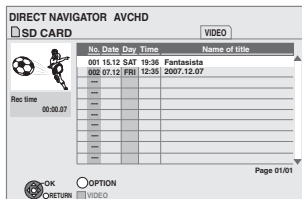

To exit the screen

Press [**EXIT**].

To display the top menu

Press [**DIRECT NAVIGATOR**].

When the top menu or the “Direct Navigator” is not displayed Refer to “Starting from a selected title” (⇒ 38) to playback.

Operation during play (⇒ 38)

Note

- Set “Play AVCHD on BD-RE/BD-R” to “On” for the disc that has high definition video (AVCHD) recorded by the camcorder and high definition quality title that was recorded on this unit. (⇒ 84)
- Multiple titles may not playback continuously depending on the disc. Press [**DIRECT NAVIGATOR**], and playback by selecting the title.
- It may pause for a few seconds on the break of images when editing such as partial deletion is performed.
- **SD** It cannot playback while recording.

Playback of the playlist created on other equipment

BD-RE BD-R RAM RW(VR)

Creation or editing of playlists cannot be done on this unit.

Preparation

- Insert a disc.
- Press [**DRIVE SELECT**] to select the BD drive.

- 1 While stopped Press [**FUNCTION MENU**].
- 2 Press [**▲**, **▼**] to select “To Others” and press [**OK**].



- 3 Press [**▲**, **▼**] to select “Playlists” and press [**OK**].

- 4 Press [**▲**, **▼**, **◀**, **▶**] to select the playlist and press [**OK**].

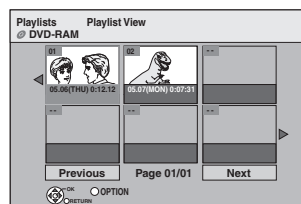

Operation during play (⇒ 38)

To return to the previous screen

Press [**RETURN**].

To exit the screen

Press [**EXIT**].

Different kinds of playback for BD-Video

BD-V

Some discs permit a variety of interactive functions in addition to the ordinary playback operation.

Showing Pop-up menu

The Pop-up menu is a special feature available with some BD-Video discs. This menu may vary with discs. For the operating method, refer to the instructions for the disc.

1 During play

Press [DIRECT NAVIGATOR].

- Pop-up menu also appears by pressing [OPTION] and selecting "Pop-up Menu".

e.g.,

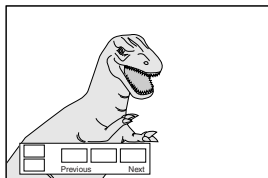

2 Press [▲, ▼, ◀, ▶] to select the item and press [OK].

To exit the screen

Press [DIRECT NAVIGATOR].

To enjoy the BONUSVIEW™ compatible BD-Video

This unit is compatible with the BONUSVIEW™ (BD-ROM version 2 Profile 1 version 1.1/Final Standard Profile), which is a new playback function of the BD-Video.

You can enjoy the secondary videos on the BD-Video, such as director commentary, the sub-stories in simultaneous progression, or viewing from different angles, in addition to the main movie recorded on the disc.

There are various playback methods depending on the discs.
Refer to the instructions attached to the disc and enjoy.

Image of the secondary video

e.g.,

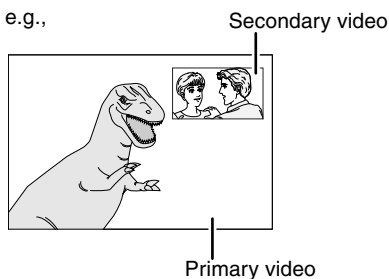

When the secondary video does not display

Turn the "Video" and "Soundtrack" to "On" in the "Secondary Video" in the "Signal Type" in the Disc menu. (➡ 76)

- Playback method set by the disc will take priority, so it may not playback in the method set in this unit.
- To output the audio of the secondary video, set the "BD-Video Secondary Audio" to "On" in the Setup menu (➡ 85).

Note

- There are functions to enjoy link-up with the SD cards in the BD-Video specification. Discs with this function may become available in the future. Enjoy the function by reading the instruction attached to the disc in that case. (current as of May 2008)
- After enjoying with above disc, if the BD-Video data recorded on the SD card is no longer needed, it can be erased by "Delete BD-Video data" of the "Card Management". Select "Delete BD-Video data" in step 1 of the "Enabling the unit's recording function—Format" (➡ 80).

Regarding High Bit rate Audio

This unit supports high bit rate audio (Dolby Digital Plus, Dolby TrueHD, DTS-HD High Resolution Audio and DTS-HD Master Audio) adopted in BD-Video.

In order to enjoy these audio formats, connect this unit to your amplifier/receiver supporting HDMI Ver. 1.3 using a High Speed HDMI cable (⇒ 95) and set “Priority Setting” (⇒ 85) to “Audio Quality”.

However, there are the following restrictions.

- The clicking sound on the menu and audio with secondary video cannot be output.
 - Any audio format not decoded by the connected amplifier/receiver cannot be output properly.
- If you want to output the audio properly, set “Priority Setting” to “Secondary Audio” or “User Setting”.

■ Differences in audio output by setting

The output audio type can be changed depending on the menu settings.

Set “Priority Setting” in accordance with your favourite audio with reference to the following table.

Secondary Audio	To enjoy secondary audio				
	Original audio	Dolby Digital Plus	Dolby TrueHD	DTS-HD High Resolution Audio	DTS-HD Master Audio
		↓	↓	↓	↓
	Audio formats are output as:	PCM			
		<ul style="list-style-type: none"> • “BD-Video Secondary Audio” is set to “On”, and “Dolby D/Dolby D +/Dolby TrueHD”, “DTS/DTS-HD”, “MPEG” are fixed to “PCM”. • Data of 6 channels or more will be output in 5.1 channels. When playing BD-Video without secondary audio or clicking sound, the audio is output as the same format as if “BD-Video Secondary Audio” was set to “Off”. 			
Audio Quality	To enjoy high bit rate audio				
	Select this mode if your amplifier/receiver is equipped with these decoders.				
	Original audio	Dolby Digital Plus	Dolby TrueHD	DTS-HD High Resolution Audio	DTS-HD Master Audio
		↓	↓	↓	↓
	Audio formats are output as:	Dolby Digital Plus	Dolby TrueHD	DTS-HD High Resolution Audio	DTS-HD Master Audio
		<ul style="list-style-type: none"> • “Dolby D/Dolby D +/Dolby TrueHD”, “DTS/DTS-HD”, “MPEG” are set to “Bitstream”, and “BD-Video Secondary Audio” is fixed to “Off”. The clicking sound on the menu and audio with secondary video is not outputted. 			
User Setting	To set the high bit rate audio and secondary audio individually				
	“BD-Video Secondary Audio”: “On”*		“BD-Video Secondary Audio”: “Off”		
	PCM	Bitstream	PCM	Bitstream	
	Maximum 5.1ch PCM	Dolby Digital	Maximum 5.1ch PCM	The original format	
	* When playing BD-Video without secondary audio or clicking sound, the audio is output as the same format as if “BD-Video Secondary Audio” was set to “Off”.				

Note

Enjoying 7.1ch LPCM

Connect this unit to your amplifier/receiver using an HDMI cable, and select “Audio Quality” or “User Setting” and then set “BD-Video Secondary Audio” to “Off”.

When the unit is connected using the DIGITAL AUDIO OUT terminal, there are restrictions for high bit rate audio.

Original audio	PCM	Bitstream	
		“BD-Video Secondary Audio”: “On”*	“BD-Video Secondary Audio”: “Off”
Dolby Digital Plus/Dolby TrueHD (7.1ch)	Down-mixed 2ch PCM	Dolby Digital	Dolby Digital
DTS-HD High Resolution Audio/DTS-HD Master Audio (7.1ch)	Down-mixed 2ch PCM	Dolby Digital	DTS Digital Surround
7.1ch LPCM	Down-mixed 2ch PCM	Down-mixed 2ch PCM	Down-mixed 2ch PCM

- When “Secondary Audio” is selected, the audio is output in the formats enclosed in bold frames.
- When “Audio Quality” is selected, the audio is output in the formats shown in the shaded area.

* When playing BD-Video without secondary audio or clicking sound, the audio is output as the same format as if “BD-Video Secondary Audio” was set to “Off”.

Regarding 24p output

Many BD-Video movie contents are recorded in 24 frames/second in accordance with the film materials. However, they will normally be output in 60 frames/second in accordance with the display format.

These are output in 24p as the original. Therefore, high-quality video can be enjoyed, such as the improved clarity, enhanced perspective, etc.

Required connection

- Connect to a TV supporting 1080/24p input via an HDMI cable.

Required setting

- “BD-Video 24p Output”: “On” (⇒ 87)

HDD **BD-RE** **RAM**
BD-R **-R** **-R DL** **-RW(V)** **+R** **+R DL** (You cannot edit finalised discs.)
+RW

Editing of the title can be performed with this unit.
 For example, an unrequired part of the title can be deleted. (⇒ 45, Partial Delete)

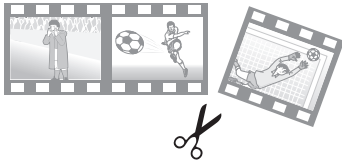

Note

- Once deleted, divided or partially deleted, recorded content cannot be restored to its original state. Make certain before proceeding.
- Restricted recording information remains even after editing (e.g. dividing a title etc).
- **BD-R** **+R** **+R DL** Each time you edit a title the information is saved to the free space on the disc. If you do this numerous times, the amount of free space decreases. We recommend that you edit on the HDD and then copy to disc.
- **-RW(VR)** Only "Properties" is possible.

Preparation

- Turn on the television and select the appropriate AV input to suit the connection to this unit.
- Turn the unit on.
- Press [DRIVE SELECT] to select the drive containing the recorded title to be edited.
- **BD-RE** **BD-R** **RAM** Release protection (⇒ 79, Setting the protection).

1 Press [DIRECT NAVIGATOR].

HDD **BD-RE** **RAM** When "VIDEO" is not selected, press the "Red" button to select "VIDEO".

2 Press [▲, ▼] to select the title.

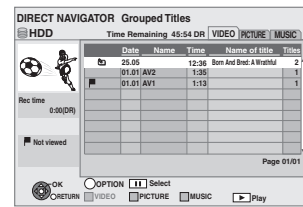

To show other pages

Press [◀, ▶].

Multiple editing

Select with [▲, ▼] and press [III]. (Repeat.)
 A check mark appears. Press [III] again to cancel.

3 Press [OPTION].

4 Press [▲, ▼] to select the operation and press [OK].

- If you select "Edit", press [▲, ▼] to select the operation and press [OK].

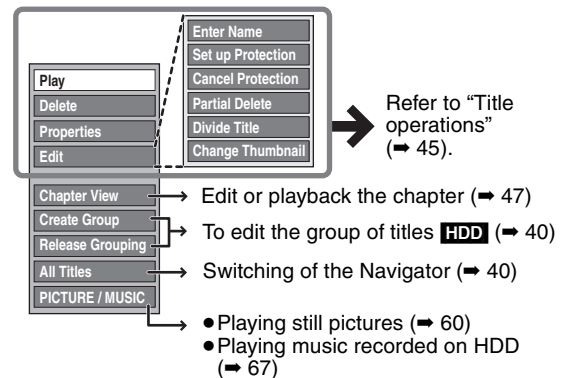

To return to the previous screen

Press [RETURN].

To exit the screen

Press [DIRECT NAVIGATOR].

Title operations

After performing steps 1–4 (⇒ 44)

Delete*

HDD BD-RE BD-R RAM -R
-R DL -RW(V) +R +R DL +RW

Press [**◀**, **▶**] to select “Delete” and press [OK].

- Once deleted, the recorded contents are lost and cannot be restored. Make certain before proceeding.
- The available recording space on BD-R, DVD-R, DVD-R DL, +R or +R DL does not increase when you delete titles.
- Available recording space on DVD-RW (DVD-Video format) and +RW increases only when the last recorded title is deleted. It does not increase if other titles are deleted (⇒ 26).

Properties

HDD BD-RE BD-R RAM -R
-R DL -RW(V) +R +R DL +RW
-RW(VR)

Information (e.g., time and date) is shown.
• Press [OK] to exit the screen.

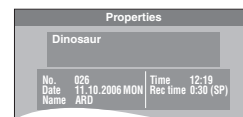

Enter Name

HDD BD-RE BD-R RAM -R
-R DL -RW(V) +R +R DL +RW

You can give names to recorded titles.
(⇒ 73, Entering text)

- **HDD** Even if the group name is changed, the title names in the group will not be changed.

Set up Protection*

HDD BD-RE BD-R RAM +R
+R DL +RW

If set, this will protect the title from accidental deletion.

Press [**◀**, **▶**] to select “Yes” and press [OK].

The lock symbol appears when the title is protected.

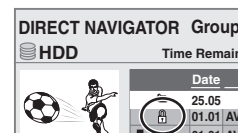

Partial Delete

HDD BD-RE BD-R RAM
(⇒ below, For your reference)

You can remove unnecessary part of the recording.

① Press [OK] at the start point and end point of the section you want to delete.

- Press [**▶**] (PLAY) to start the playback when the title is paused.

② Press [**▲**, **▼**] to select “Continue” and press [OK].

- Select “Next” and press [OK] to delete other sections. Up to 20 sections can be set. (⇒ go to step ①)

③ Press [**◀**, **▶**] to select “Delete” and press [OK].

- Chapter Mark is generated in the scene that was partially deleted.

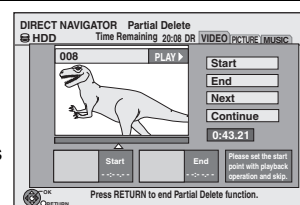

Divide Title

HDD BD-RE BD-R RAM
(⇒ below, For your reference)

You can divide a title into two.

① Press [OK] at the point you want to divide the title.

② Press [**▲**, **▼**] to select “Continue” and press [OK].

③ Press [**◀**, **▶**] to select “Divide” and press [OK].

To confirm the division point

Press [**▲**, **▼**] to select “Preview” and press [OK]. (The unit plays 10 seconds before and after the division point.)

To change the division point

Restart play and press [**▲**, **▼**] to select “Divide”, then press [OK] at the point where you want to divide the title.

Note

- The divided titles retain the title name and CPRM property (⇒ 114) of the original title.
- Video and audio just before and after the dividing point may momentarily cut out.
- **HDD** Divided titles form a group of titles.

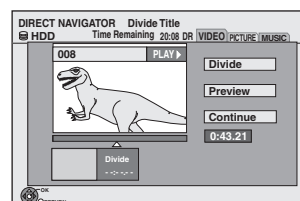

Change Thumbnail

HDD RAM -R -R DL -RW(V)
+R +R DL +RW

(⇒ below, For your reference)

- Not for the titles with displayed

-R -R DL -RW(V) +R +R DL It is possible to change the image displayed on the top menu after finalising.

+RW It is possible to change the image displayed on the top menu after creating Top Menu.

HDD Settings for the “Change Thumbnail” is saved when high speed copy is performed to DVD-R, DVD-R DL, DVD-RW (DVD-Video format), +R, +R DL or +RW.

① Press [**▶**] (PLAY) to start play.

② Press [OK] when the image you want to use as a thumbnail is shown.

To change the thumbnail

Restart play and press [**▲**, **▼**] to select “Change”, then press [OK] at the point you want to change.

③ Press [**▲**, **▼**] to select “Finish” and press [OK].



* Multiple editing is possible.

For your reference

- Use Search (⇒ 38), Time Slip (⇒ 39) to find the desired point.
- To find the desired point correctly, use Slow-motion (⇒ 38) and Frame-by-frame (⇒ 38).
- To skip to the start or end of a title, press [**◀◀**] (start) or [**▶▶**] (end).

HDD BD-RE BD-R RAM

Regarding Chapters

Programmes are recorded as a single title consisting of one chapter.

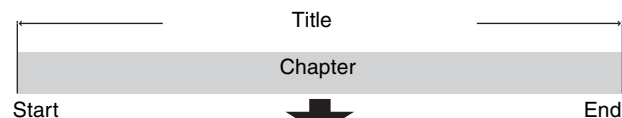

HDD BD-RE BD-R RAM You can divide a title into multiple chapters. Each section between the division points (Chapter Marks) becomes a chapter.

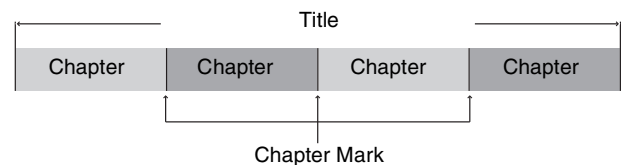

- The maximum number of chapters on a disc:
(Depends on the state of recording.)

HDD : Approx. 1000 per title

BD-RE BD-R RAM -R -R DL -RW(V) :Approx. 1000

+R +R DL +RW :Approx. 254

Note

- **HDD** You will not be able to perform the Resume play function (→ 38) or the “Change Thumbnail” (→ 45) with a title with the maximum number of chapters.
- **HDD** Chapter Marks created will be maintained when copied. But, it will not maintain the exceeded amount if it exceeds the maximum chapter numbers.
- **-R -R DL -RW(V) -RW(VR) +R +R DL +RW** Only playback is possible.

Create Chapter Mark

During the playback or pause

Press [**CREATE CHAPTER**].

- Chapters are divided at the point pressed.

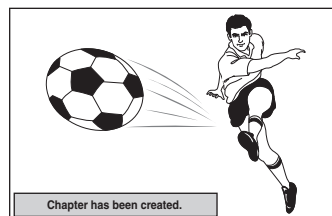

■ To delete the Chapter Mark

- 1 While paused
Press [**⏪**, **⏩**] and skip to the location you want to delete.
- 2 Press [**CREATE CHAPTER**].
- 3 Press [**◀**, **▶**] to select “Yes” and press [**OK**].

Editing and playing chapters

1 Press [DIRECT NAVIGATOR].

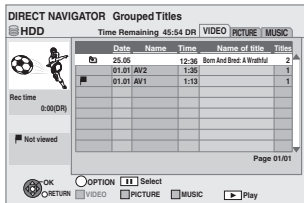

HDD **BD-RE** **RAM** When “VIDEO” is not selected, press the “Red” button to select “VIDEO”.

2 Press [▲, ▼] to select the title and press [OPTION].

3 Press [▲, ▼] to select “Chapter View” and press [OK].

4 Press [◀, ▶] to select the chapter.

To start play → Press [OK].

To edit → Step 5.

To create → Press the “Green” button. (→ right)

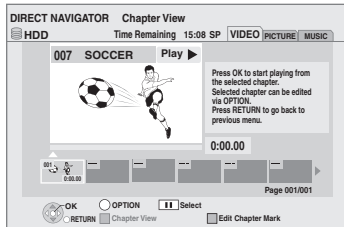

Chapter View screen

5 Press [OPTION], then [▲, ▼] to select the operation and press [OK].

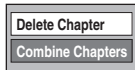

→ Refer to “Chapter operations”.

To return to the previous screen

Press [RETURN].

To exit the screen

Press [EXIT].

Chapter operations

After performing steps 1–4 (→ left)

Create Chapter

Select the point where you want to start a new chapter while viewing the title.

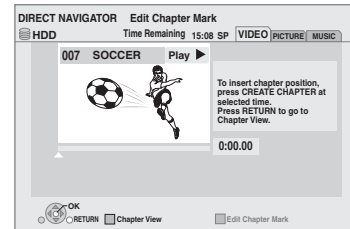

- ① Press [CREATE CHAPTER] at the point you want to divide.
 - Repeat this step to divide at other points.
- ② Press [RETURN] to go to Chapter View screen.

After performing steps 1–5 (→ left)

Delete Chapter^{**}

Press [◀, ▶] to select “Delete” and press [OK].

- Once deleted, the recorded contents are lost and cannot be restored. Make certain before proceeding.
- Select “Combine Chapters” (→ below) when you only want to delete the division point between chapters. (The recorded contents will not be deleted.)

Combine Chapters

Press [◀, ▶] to select “Combine” and press [OK].

- The selected chapter and following chapter are combined.

* Multiple editing is possible.

Copying titles

There are following copying methods.

Copy	Easy copying from HDD to disc with no difficult settings. (⇒ 27)
Copy Title Playing	Copy the playing title on the HDD to the disc. (⇒ 51)
Advanced Copy	Make a copying list and then copy. You can set the unit to copy titles in the way you want. (⇒ 52)
Copy AVCHD	High definition video (AVCHD format) can be copied from disc, SD card, or USB. (⇒ 58)

■ Copy direction

Copy source	Copy destination	Possible copying method	Copy speed
HDD	BD-RE BD-R RAM -R -R DL -RW(V) +R +R DL +RW	Copy Copy Title Playing Advanced Copy	<ul style="list-style-type: none"> The high speed copy may not be possible depending on the destination disc or the title to copy. (⇒ 50, When is the time high speed copy is not possible?)
BD-RE BD-R	HDD	Advanced Copy	Normal speed
RAM -RW(VR)	HDD	Advanced Copy	High speed
+RW	HDD	Advanced Copy	Normal speed
Before finalise -R -R DL -RW(V) +R +R DL	Cannot copy		
DVD-V After finalise -R -R DL -RW(V) +R +R DL	HDD	Advanced Copy	Normal speed
SD Video (MPEG2 format) <ul style="list-style-type: none"> From an SD card or a video equipment (from USB) 	HDD RAM	Advanced Copy	High speed
	BD-RE BD-R -R -R DL -RW(V) +R +R DL +RW	Cannot copy	
HD Video (AVCHD format) <ul style="list-style-type: none"> From discs 	HDD	Copy AVCHD	High speed
HD Video (AVCHD format) <ul style="list-style-type: none"> From an SD card or a video equipment (from USB) 	HDD	Copy AVCHD	High speed
	BD-RE BD-R	Copy AVCHD	High speed
	RAM -R -R DL -RW(V) +R +R DL +RW	Cannot copy	

■ Copy speed

(○: Possible, -: Impossible)

	High speed mode	Normal speed mode
Features	Copy with shorter time than the recorded time of the title with same quality (recording mode).	It will take same or longer time as the recorded time of the copying title. ● If you select a recording mode with better picture quality than the original, the picture quality does not improve.
Are chapters maintained?	○*1	-
Are thumbnails maintained?	○	-
Recording and Playing while Copying	○*2	-

*1 Position of the chapter might shift slightly.

It will not maintain the exceeded amount if it exceeds the maximum chapter numbers.

- **BD-RE** **BD-R** **RAM** **-R** **-R DL** **-RW(V)** :Approx. 1000

- **+R** **+R DL** **+RW** :Approx. 100

(Depends on the state of recording.)

*2 Possible only with titles on the HDD

[However it is not possible when copying with automatic finalisation or when copying SD Video (MPEG2 format) or when copying HD Video (AVCHD format).]

- You cannot perform chasing play or edit, etc. while copying.

- Still pictures or music cannot be played.

■ Approximate copying times (Max. speed)

(excludes time required to write data management information)

HDD		5X Speed DVD-RAM		16X Speed DVD-R*1		4X Speed DVD-R DL*2		6X Speed DVD-RW*3		8X Speed +R*4		4X Speed +R DL*2		4X Speed +RW	
Recording Mode	Recorded	Required time	Speed	Required time	Speed	Required time	Speed	Required time	Speed	Required time	Speed	Required time	Speed	Required time	Speed
XP	1 hour	12 min.	5x	5 min. 46 s.	10x	15 min.	4x	15 min.	4x	8 min. 20 s.	7x	15 min.	4x	15 min.	4x
SP		6 min.	10x	2 min. 30 s.	24x	7 min. 30 s.	8x	7 min. 30 s.	8x	3 min. 45 s.	16x	7 min. 30 s.	8x	7 min. 30 s.	8x
LP		3 min.	20x	1 min. 21 s.	44x	3 min. 45 s.	16x	3 min. 45 s.	16x	1 min. 53 s.	32x	3 min. 45 s.	16x	3 min. 45 s.	16x
EP (6H)		2 min.	30x	58 s.	62x	2 min. 30 s.	24x	2 min. 30 s.	24x						
EP (8H)		1 min. 30 s.	40x	48 s.	75x	1 min. 53 s.	32x	1 min. 57 s.	31x						

HDD		2X Speed BD-RE DL (50 GB)		2X Speed BD-RE (25 GB)		4X Speed BD-R DL (50 GB)		4X Speed BD-R (25 GB)	
Recording Mode	Recorded	Required time	Speed	Required time	Speed	Required time	Speed	Required time	Speed
DR*5	1 hour	15 min.	4x	15 min.	4x	7 min. 30 s.	8x	7 min. 30 s.	8x

● The above values indicate the quickest possible times and speeds to high speed copy a one hour title recorded on the HDD to a high speed recording compatible disc. Depending on what part of the disc is being written to, the features of the disc, etc., the times and speeds will vary.

*1 In this unit, copying with a 16X Speed DVD-R disc will be performed at the same speed as with a 12X Speed DVD-R disc.

*2 In this unit, copying with 8X Speed discs, DVD-R DL and +R DL, will be performed at the same speed as with 4X Speed discs, DVD-R DL and +R DL.

*3 In this unit, copying with a 6X Speed DVD-RW disc will be performed at the same speed as with a 4X Speed DVD-RW disc.

*4 In this unit, copying with a 16X Speed +R disc will be performed at the same speed as with a 8X Speed +R disc.

*5 In case that the bit rate of broadcasting is 15 Mbps.

Note

● When recording or playing while copying, the unit may not use the maximum recording speed.

● Depending on the condition of the disc, the unit may not copy using the maximum speed.

■ Frequently asked questions

<p>When is the time high speed copy is not possible?</p>	<p>It will copy at normal speed in following cases:</p> <ul style="list-style-type: none"> ● Copying XP, SP, LP, EP, or FR mode title to the BD-RE or BD-R ● RAM -R -R DL -RW(V) +R +R DL +RW Copying to in following conditions: <ul style="list-style-type: none"> – Titles in DR mode – Title of the AVCHD copied to the HDD ● -R -R DL -RW(V) +R +R DL +RW Copying to in following conditions: <ul style="list-style-type: none"> – Copy including a title that was recorded to HDD with “Rec for High Speed Copy” set to “Off” – Titles that contain many deleted segments. – Titles that have been copied to the HDD from an SD card or a Panasonic digital video camera with HDD (SD Video). – +R +R DL +RW Titles recorded in “EP” mode and “FR (recordings 5 hours or longer)” mode. – +R +R DL +RW Titles recorded in 16:9 aspect – -R -R DL -RW(V) Titles recorded in 16:9 aspect using “EP” mode or “FR” (recordings 5 hours or longer) mode ● Setting the “Recording Mode” to anything but “High Speed” in “Advanced Copy” ● Copying from BD-RE, BD-R, +RW to HDD ● -R -R DL -RW(V) +R +R DL When copying from the finalised disc to HDD
<p>When copying titles in high speed mode to high speed recording compatible discs</p>	<p>The sound of the disc rotating becomes louder than normal. If you want copy to perform more quietly, select “Normal (Silent)” in “BD/DVD Speed for High Speed Copy” in the Setup menu (➔ 84).</p>
<p>-R -R DL -RW(V) +R +R DL +RW When copying to disc in normal speed mode</p>	<p>When not copying in high speed mode, titles are temporarily copied at normal speed to the HDD and then copied at high speed to the disc. The titles that were temporarily copied to the HDD are then deleted. You cannot copy to the disc in the following cases.</p> <ul style="list-style-type: none"> – When there is not enough free space on the HDD. (When copying to a new blank disc, if you intend to fill a new disc when copying to it, the equivalent of up to 4 hours of free space in SP mode is needed on the HDD.) – When the number of titles recorded to the HDD and the number of titles to be copied to the disc is greater than 499 in total.
<p>When stopping the copy during copy</p>	<p>When High-speed copying All titles that have completely copied at the point cancelled are copied.</p> <p>When Normal Speed copying Copies until the point cancelled. However titles with “One time only recording” restriction, only titles that have completely copied at the point cancelled are copied to the disc. Titles that are cancelled before the copy is complete are not copied and remain on the HDD.</p> <ul style="list-style-type: none"> ● -R -R DL -RW(V) +R +R DL +RW If copy is cancelled during the step while temporarily copying to the HDD, then nothing will be copied. However, if copy is cancelled during the step while copying to disc from the HDD, then only titles completely copied at the point canceled are copied. <p>Even if the title was not copied to the BD-R, DVD-R, DVD-R DL, DVD-RW (DVD-Video format), +R, +R DL or +RW, the amount of remaining writable disc space becomes less.</p>
<p>Is it possible to copy to the disc, SD card, or USB memory after copying HD video (AVCHD format) to the HDD?</p>	<ul style="list-style-type: none"> ● It can be copied to the disc. <ul style="list-style-type: none"> – BD-RE BD-R It can be copied with HD quality. – RAM -R -R DL -RW(V) +R +R DL +RW It will be copied with SD quality. (It cannot be copied as it is in HD picture quality.) ● It cannot be copied to SD card or USB memory.

Copy Title Playing

Copy the playing title on the HDD to the disc.

- It will start copying from the beginning of the title regardless of the playing position.

HDD → **BD-RE** **BD-R** **RAM** **-R** **-R DL** **-RW(V)** **+R** **+R DL** **+RW**

1 Playback the title to copy.

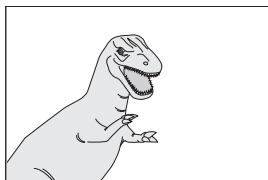

When copying the title in DR mode with multiple audio and subtitles

BD-RE **BD-R**

- There is no need to select. Audio and subtitles can be copied as is.

RAM **-R** **-R DL** **-RW(V)** **+R** **+R DL** **+RW**

- Only the audio selected in the “Multi Audio” of the Disc menu will be copied for the multiple audio. (→ 76)
- Subtitle will not be copied.

2 Press [OPTION].

3 Press [▲, ▼] to select “Copy Title Playing” and press [OK].

4 Press [◀, ▶] to select “Start” and press [OK].

To stop copying

Press and hold [RETURN] for 3 seconds.

To return to the previous screen

Press [RETURN].

Recording and playing while copying

You can record and play using the HDD while high speed copying. (Only when high speed copying)

- Still pictures and music recorded on the HDD cannot be played. Press [OK] to cancel the screen display.
- **To confirm the current progress**
Press [STATUS ⓘ].

Note

- Timer recordings executed while copying are recorded to the HDD regardless of the recording drive settings. (Only when high speed copying)

Speed and recording mode when copying

For titles in DR mode

- **BD-RE** **BD-R**
– High speed (recording mode as is)
- **RAM** **-R** **-R DL** **-RW(V)** **+R** **+R DL** **+RW**
– Normal speed (FR mode)

For titles in XP, SP, LP, EP, or FR modes

- **BD-RE** **BD-R**
– Normal speed (Recording mode of playing title)
- **RAM**
– High speed (recording mode as is)
[When the copy destination (disc) does not have enough space, copy will perform at normal speed.]
- **-R** **-R DL** **-RW(V)** **+R** **+R DL** **+RW**
Titles recorded with the “Rec for High Speed Copy” settings
“On”: High speed (recording mode as is)
“Off”: Normal speed (Recording mode of playing title)

In the following cases, even if “Rec for High Speed Copy” is set to “On”, copy will perform at normal speed.

- **+R** **+R DL** **+RW** When the copying source was recorded in “EP” or “FR (recordings 5 hours or longer)” mode.
- When the copy destination (disc) does not have enough space.
- When the title aspect for the copying source and “Aspect for Recording” do not match.
- When the title aspect for the copying source is 16:9:
 - **+R** **+R DL** **+RW**
 - **-R** **-R DL** **-RW(V)** copying source was recorded in “EP” or “FR (recordings 5 hours or longer)” mode.

Copying using the copying list— Advanced Copy

HDD ↔ BD-RE BD-R RAM +RW
 -RW(VR) → HDD
 HDD → -R -R DL -RW(V) +R +R DL
 SD → HDD RAM

You can order titles as desired for copy to disc.

- 1 While stopped
Press [FUNCTION MENU].
- 2 Press [▲, ▼] to select “To Others” and press [OK].
- 3 Press [▲, ▼] to select “Advanced Copy” and press [OK].

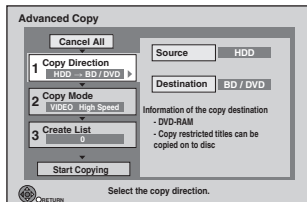

- If you are not going to change the registered list press [▼] several times (→ step 7).

- 4 Set the copy direction.
 - If you are not going to change the copying direction, press [▼] (→ step 5).
 - ① Press [▲, ▼] to select “Copy Direction” and press [▶].
 - ② Press [▲, ▼] to select “Source” and press [OK].
 - ③ Press [▲, ▼] to select the drive and press [OK].
If you select “HDD”, “Destination” is automatically set to “BD/DVD”, or vice versa. (→ Go to step ⑥)
 - ④ Press [▲, ▼] to select “Destination” and press [OK].
 - ⑤ Press [▲, ▼] to select the drive and press [OK].
The same drive as the copy source cannot be copied.
 - ⑥ Press [◀] to confirm.

- 5 Set the recording mode.
 - If you are not going to change the recording mode, press [▼] (→ step 6).
 - ① Press [▲, ▼] to select “Copy Mode” and press [▶].
 - ② Press [▲, ▼] to select “Format” and press [OK].
 - ③ Press [▲, ▼] to select “VIDEO” and press [OK].
 - ④ Press [▲, ▼] to select “Recording Mode” and press [OK].
 - ⑤ Press [▲, ▼] to select the mode and press [OK].
 - ⑥ Press [◀] to confirm.

- 6 Register titles for copy.
 - If you are going to copy a registered list without making any changes to it (→ step 7).
 - ① Press [▲, ▼] to select “Create List” and press [▶].

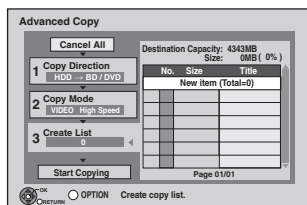

- ② Press [▲, ▼] to select “New item” and press [OK].

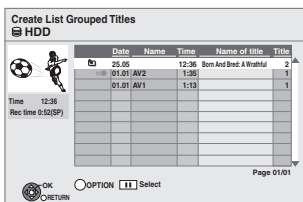

- ③ Press [▲, ▼] to select the title and press [■].
A check mark is displayed. Repeat this step until you select all necessary items.
 - Press [■] again to cancel.
 - The items will be copied in the order of the copying list. If you want to specify the order, repeat selecting one item at a time.

- When copying to a disc using high speed mode, only titles indicated with “▶▶▶” can be registered.

- To show other pages
Press [◀◀, ▶▶].

- ④ Press [OK].
- To edit the copying list (→ 53)

You cannot start copying when the value of the “Size” (→ 53) exceeds 100% (“Destination Capacity” is not sufficient).

- ⑤ Press [◀] to confirm.

7 Set to make it possible to play on other equipment.

(“Finalise” or “Create Top Menu”)

(HDD → -R -R DL -RW(V) +R +R DL +RW only)

Press [▼] if it is not to be set (→ step 8)

- ① Press [▲, ▼] to select “Other setting” and press [▶].
- ② Press [OK].
- ③ Press [▲, ▼] to select “On” or “Off” and press [OK].

- If “On” is selected

– -R -R DL -RW(V) +R +R DL. After finalising, the discs become play-only and you can also play them on other DVD equipment. However, you can no longer record or edit.

– +RW Create the Top Menu. Top Menu is a convenient function. We recommend you create the menu before playing a +RW disc on other equipment.

- ④ Press [◀] to confirm.

8 Press [▲, ▼] to select “Start Copying” and press [OK].

9 Press [◀, ▶] to select “Yes” and press [OK] to start copying.

To stop copying

Press and hold [RETURN] for 3 seconds.
(You cannot stop while finalising)

To return to the previous screen

Press [RETURN].

Recording and playing while copying

You can record and play using the HDD while high speed copying.
(Only when high speed copying without finalising)

- Still pictures and music recorded on the HDD cannot be played.

Press [OK] to cancel the screen display.

- To confirm the current progress







Press [STATUS ①].

Note

- Titles in the grouped titles and other titles cannot be registered simultaneously.
- Timer recordings executed while copying are recorded to the HDD regardless of the recording drive settings.
(Only when high speed copying without finalising)

COPY Navigator/Copying list icons and functions

COPY Navigator/Copying list indicators

-  Titles that can be copied in high speed mode to the inserted disc
-  Title with "One time only recording" restriction (⇒ 29, When recording the "One time only recording" broadcasts)
-  Titles deleted from the HDD by "One time only recording" restriction after copying. (⇒ 29, When recording the "One time only recording" broadcasts)
-  Title contains still picture(s)
 - Still picture(s) cannot be copied.
-  (NTSC) Title recorded using a different encoding system from that of the TV system currently selected on the unit.
-  (PAL) Titles displaying these marks cannot be selected.

Data size of each registered item

No.	Size	Title
	New Item	(Total=0)

Page 01/01

Size:

Data size recorded to the copy destination

- When copying at normal speed, the total data size will change according to the recording mode.
- The total data size shown may be larger than the sum of the data sizes for each registered item, because of data management information being written to the copy destination, etc.

To play DVD-R, DVD-R DL, DVD-RW (DVD-Video format), +R and +R DL on other players, it is necessary to finalise them after copy.

■ To check the properties of a title and sort COPY Navigator/Copying list

- 1 Press [**▲**, **▼**] to select the title and press [OPTION].

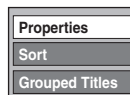

- 2 Press [**▲**, **▼**] to select "Properties" or "Sort" and press [OK].

Properties:

The name, recording date, channel etc. of the selected title are shown. (You cannot select a title if it has a check mark.)

Sort (All Titles screen only):

Press [**▲**, **▼**] to select the item and press [OK].

This changes the way that titles are displayed. You can select to display titles by No., recording date, day, channel, recording start time and title name. (You cannot select a title if it has a check mark.) If you close the COPY Navigator/Copying list screen, the display order is cancelled.

■ To edit the copying list

Select the item in step 6-④ (⇒ 52)

- ① Press [OPTION].
- ② Press [**▲**, **▼**] to select the operation and press [OK].

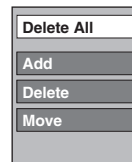

Delete All:

Delete all items registered on the copying list.

Press [**◀**, **▶**] to select "Yes" and press [OK].

Add:

Add new items to the copying list.

- 1 Press [**▲**, **▼**] to select the title and press [III].
A check mark is displayed. Repeat this step until you select all necessary items.
 - Press [III] again to cancel.
- 2 Press [OK].

Delete:

Delete the selected items.

Press [**◀**, **▶**] to select "Yes" and press [OK].

Move:

Move selected items or change the order of items on the copying list.

Press [**▲**, **▼**] to select the destination and press [OK].

To cancel all registered copying setting and lists

After performing steps 1-3 (⇒ 52)

- 1 Press [**▲**, **▼**, **◀**, **▶**] to select "Cancel All" and press [OK].
 - 2 Press [**◀**, **▶**] to select "Yes" and press [OK].
- The settings and lists may be cancelled in the following situations.
 - When a title, still picture, etc. has been recorded or deleted at the copy source
 - When steps have been taken, for instance, to turn off the unit, open the tray, change the copy direction, etc.

Copying a finalised DVD-R, DVD-R DL, DVD-RW (DVD-Video format), +R and +R DL

DVD-V → HDD

You can copy the content of finalised DVD-R, DVD-R DL, DVD-RW (DVD-Video format), +R, and +R DL to the HDD and re-edit. While playing a disc, the content being played is copied to the HDD according to the set time.

- When “Rec for High Speed Copy” (⇒ 84) is set to “On” and you make a copy, the copy will be made using the picture size selected in “Aspect for Recording” (⇒ 84) of the Setup menu.

- Operations and on screen displays during copy are also recorded.
- Almost all DVD-Video on sale have been treated to prevent illegal copying, and cannot be copied.

Preparation

- Insert the finalised disc (⇒ 15).

After performing steps 1–5 (“Format” is automatically set to “DVD-Video”) (⇒ 52, Copying using the copying list—Advanced Copy)

1 Set “Copy Time”.

- If you are not going to change the setting (⇒ step 2).

■ Setting the unit to copy according to the set time

- 1 Press [▲, ▼] to select “Copy Time” and press [▶].
 - 2 Press [▲, ▼] to select “Time Setting” and press [OK].
- Setting the unit to copy all the content on the disc
 - 3 Press [▲, ▼] to select “Off” and press [OK].
 - 4 Press [◀] to confirm.

Copy will continue until there is not enough available recording space on the HDD.
 - Setting the copying time
 - 3 Press [▲, ▼] to select “On” and press [OK].
 - 4 Press [▲, ▼] to select “Copy Time” and press [OK].

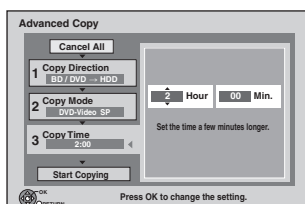

- 5 Press [◀, ▶] to select “Hour” and “Min.” and press [▲, ▼] to set the recording time.
 - 6 Press [OK].
 - 7 Press [◀] to confirm.
- Copying to the HDD continues for the set time even after the content being played finishes.

- Set a few minutes longer than the source title, in order to include the operation time before play begins.

2 Press [▲, ▼] to select “Start Copying” and press [OK].

3 Press [◀, ▶] to select “Yes” and press [OK] to start copying.

The disc top menu is displayed.

- Disc play automatically begins from title 1 when “Title 1” is selected from the “Auto-Play Select” menu when finalising the disc (⇒ 81).

4 When the top menu is displayed Press [▲, ▼, ◀, ▶] to select the title you want to start copying, and press [OK].

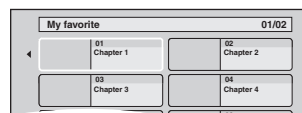

While playing in order, all the titles after the selected title are recorded until the set time. (After the last title on the disc has finished playing the top menu is recorded until the set time is reached.)

To return to the previous screen

Press [RETURN].

To stop copying

Press [■].

You can also press and hold [RETURN] for 3 seconds to stop copying.

- If stopped partway, copying will be up to that point.

Note

- The screen on the right is recorded at the beginning.
- The content is recorded as 1 title from the start of copy to the end.
- If play does not begin automatically or if the top menu does not display automatically, press [▶] (PLAY) to start.
- Even if you copy a high quality video/audio DVD, the original picture and audio quality cannot be exactly replicated.
- If you want to copy a title from a finalised DVD-RW (DVD Video Recording format), create a copy list and then copy (⇒ 52, Copying using the copying list—Advanced Copy).



HDD

See also “Important notes for recording” (⇒ 28).

e.g., Connecting to the AV3 terminals on the front

- Turn off the unit and external equipment before connecting.

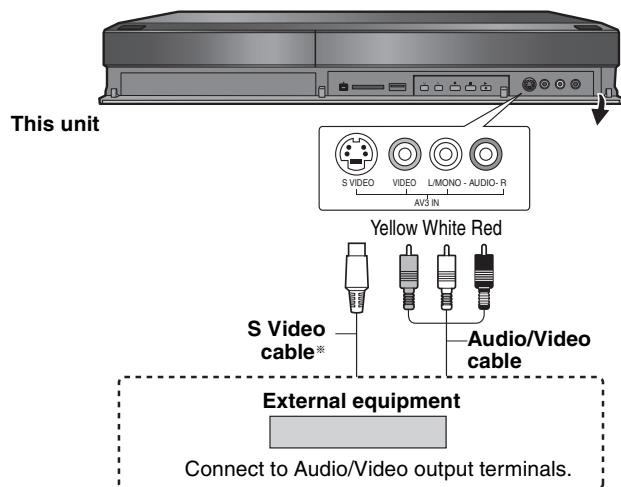

* The S VIDEO terminal achieves a more vivid picture than the VIDEO terminal.

Preparation

- Press [DRIVE SELECT] to select the HDD drive.
- When the output signal from the external equipment is NTSC, change the “TV System” to “NTSC” in the Setup menu (⇒ 87).

1 While stopped
Press [INPUT SELECT] to select the input channel for the equipment you have connected.

e.g., If you have connected to AV3 input terminals, select “AV3”.

2 Press [REC MODE] to select the recording mode.

- DR, FR mode cannot be selected.

3 Select the channel on the other equipment.

4 Press [● REC].

Recording starts.

To skip unwanted parts

Press [II] to pause recording. (Press again to restart recording.)

To stop recording

Press [■].

e.g., Connecting to the AV3 or DV input terminals on the front

- Turn off the unit and other video equipment before connecting.

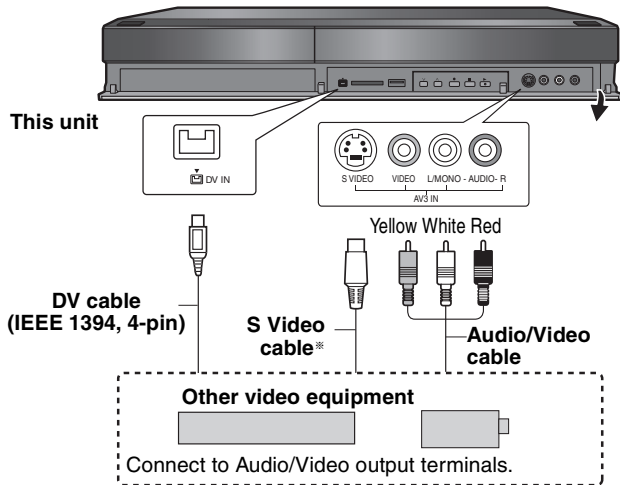

If the audio output of the other equipment is monaural
Connect to L/MONO on the AV3 input terminals at the front.
* The S VIDEO terminal achieves a more vivid picture than the VIDEO terminal.

When recording from the unit's DV terminal

- Use only DV cable with ferrite core.
- Select the type of audio recording from "Audio Mode for DV Input" in the Setup menu (⇒ 86).
- When recording from DV equipment (e.g., digital video camcorder), you can record audio/video recordings from DV tape only.
- When "Rec for High Speed Copy" (⇒ 84) is set to "On" and you make a copy, the copy will be made using the picture size selected in "Aspect for Recording" (⇒ 84) of the Setup menu.

Recording of 16:9 image such as wide broadcasting (⇒ 28)

Note

- If video is copied from another piece of equipment to this unit, then the video quality will be degraded.
- While copying from DV input or executing the "Recording via AV3 input"
 - Copy will stop when timer recording starts.
 - Chasing playback, simultaneous rec and play, switching of the broadcast or input cannot be performed.

Manual recording

HDD

Preparation

- Press [DRIVE SELECT] to select the HDD drive.
- When recording bilingual programmes (⇒ 28, Important notes for recording)
- When the output signal from the external equipment is NTSC, change the "TV System" to "NTSC" in the Setup menu (⇒ 87).

1

While stopped

Press [INPUT SELECT] to select the input channel for the equipment you have connected.

e.g., If you have connected to AV3 input terminals, select "AV3".

2

Press [REC MODE] to select the recording mode.

- DR, FR mode cannot be selected.

3

Start play on the other equipment.

4

When you want to start recording

Press [● REC].

Recording starts.

To skip unwanted parts

Press [II] to pause recording. (Press again to restart recording.)

To stop recording

Press [■].

Using Flexible Recording (⇒ 32)

Almost all videos and BD-Video/DVD-Video on sale have been treated to prevent illegal copying. Any software that has been so treated cannot be recorded using this unit.

DV automatic recording (DV Auto Rec)

HDD BD-RE BD-R RAM -R -RW(V) +R +RW

Preparation

- 1 Turn off the main unit and DV equipment, then connect the equipment with the unit's DV input terminal (⇒ 56).
 - 2 Turn on the main unit.
- When the output signal from the external equipment is NTSC, change the "TV System" to "NTSC" in the Setup menu (⇒ 87).

1 Turn on the DV equipment, and pause play at the point you want recording to start.

The following screen appears.

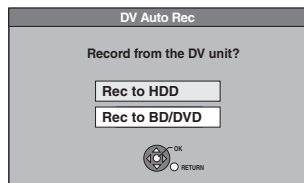

• When the screen is not displayed

After performing step 1

- 1 Press [FUNCTION MENU].
- 2 Press [▲, ▼] to select "To Others" and press [OK].
- 3 Press [▲, ▼] to select "DV Auto Rec" and press [OK].
→ Go to step 2

2 Press [▲, ▼] to select "Rec to HDD" or "Rec to BD/DVD" and press [OK].

- It may take a while for the next screen to display while preparing to record.

3 Press [REC MODE] to select the recording mode.

- DR, FR mode cannot be selected.

4 Press [◀, ▶] to select "Start" and press [OK].

Recording starts.

To stop recording

Press [■].

Note

- Only one piece of DV equipment (e.g., digital video camcorder) can be connected to the unit via the DV input terminal.
- It is not possible to operate the unit from the connected DV equipment.
- The DV input on this unit is for use with DV equipment only. (It cannot be connected to a computer, etc.)
- The DV equipment name may not be shown correctly.
- Depending on the DV equipment, the images or audio may not be input properly.
- The date and time information on the tape of the DV equipment will not be recorded.
- **-R** It may not be able to record after repeating about 30 times of step 2 or recording or editing.
- **+R +RW** Chapters for every 8 minutes are created automatically.

If the DV automatic recording function does not work properly, check the connections and DV equipment settings, and turn the unit off and back on.

If that does not work, follow the instructions for manual recording (⇒ 56).

Recording via AV3 input

BD-RE BD-R RAM -R -RW(V) +R +RW

It is possible to record to disc from equipment connected to the AV3 input terminals.

Preparation

- Press [DRIVE SELECT] to select the BD drive.
- When the output signal from the external equipment is NTSC, change the "TV System" to "NTSC" in the Setup menu (⇒ 87).

- 1 While stopped
Press [FUNCTION MENU].
- 2 Press [▲, ▼] to select "To Others" and press [OK].
- 3 Press [▲, ▼] to select "Recording via AV3 input" and press [OK].

- It may take a while for the next screen to display while preparing to record.

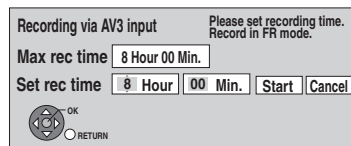

4 Press [◀, ▶] to select "Hour" and "Min." and press [▲, ▼] to set the recording time.

- You can also set the recording time with the numbered buttons.

5 Start play on the other equipment.

6 When you want to start recording

Press [◀, ▶] to select "Start" and press [OK].

- Record in FR mode.

To exit the screen without recording

Press [RETURN].

To stop recording partway

Press [■].

To show the remaining time

Press [STATUS ⓘ].

Note

- **-R** It may not be able to record after repeating about 30 times of step 3 or recording or editing.
- **+R +RW** Chapters for every 8 minutes are created automatically.

Copy the HD Video (AVCHD format) or the SD Video (MPEG 2 format)

It is possible to copy the HD video (AVCHD format) or the SD video (MPEG 2 format) recorded on the Panasonic digital video camera to the HDD or disc.

Copying HD Video (AVCHD format)

From an SD card or Discs

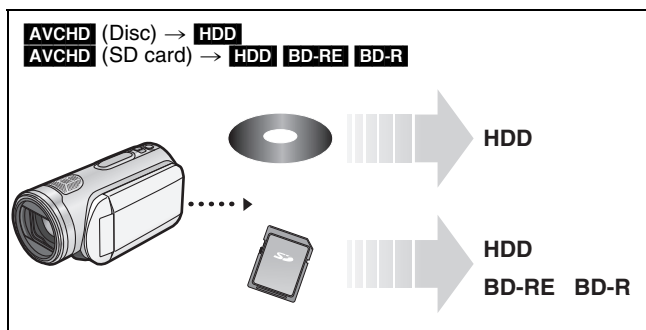

1 Insert a disc or card.

e.g., **SD**

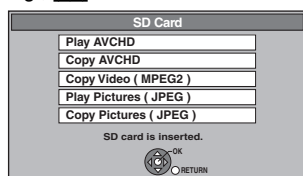

2 Press [▲, ▼] to select “Copy AVCHD” and press [OK].

3 When copying from an SD card

Press [▲, ▼] to select “Copy to HDD” or “Copy to BD” and press [OK].

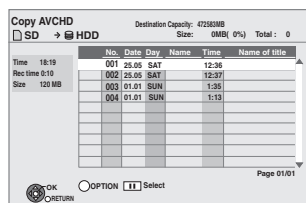

4 Press [▲, ▼] to select the title and press [II].

A check mark is displayed. Repeat this step until you select all necessary titles.

• Press [II] again to cancel.

(All the recordings on the same date become a title.)

5 Press [OK].

6 Press [◀, ▶] to select “Start” and press [OK].

It will automatically format the unformatted disc, such as new disc, when copying.

From a video equipment

Camera's HDD → **HDD BD-RE BD-R**

• You cannot playback HD Video in the camera's HDD with this unit.

You must copy the files to the HDD or disc.

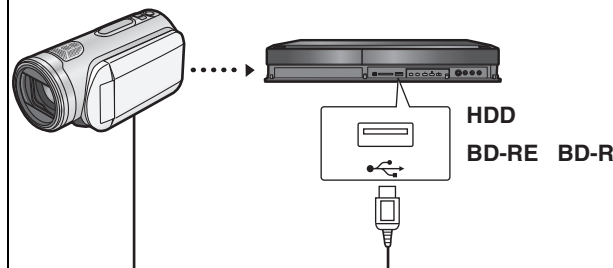

Preparation

Turn on both this unit and the camera.

1 Connect the camera to this unit.

2 Select the appropriate mode that makes the camera ready for data transfer (such as “PC CONNECT”) on the camera.

• Refer to the camera's operating instructions for detail.

e.g.,

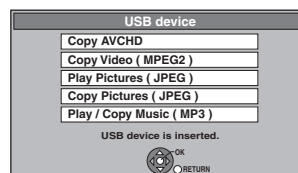

3 Press [▲, ▼] to select “Copy AVCHD” and press [OK].

4 Press [▲, ▼] to select “Copy to HDD” or “Copy to BD” and press [OK].

5 Press [▲, ▼] to select the title and press [II].

A check mark is displayed. Repeat this step until you select all necessary titles.

• Press [II] again to cancel.

(All the recordings on the same date become a title.)

6 Press [OK].

7 Press [◀, ▶] to select “Start” and press [OK].

It will automatically format the unformatted disc, such as new disc, when copying.

To stop copying

Press and hold [RETURN] for 3 seconds.

Note

- Record, playback, or timer recording cannot be executed while copying.
- Title with more than 256 scenes cannot be copied.
- Copied video will be displayed as “AVCHD” in the “Name” column of the Direct Navigator screen.
- Depending on the recording condition with the high definition camera, scenes recorded on same day might have different titles (“-1”, “-2” appended to date).
- See the instructions of the equipment used to record.

Copying SD Video (MPEG 2 format)

■ From an SD card

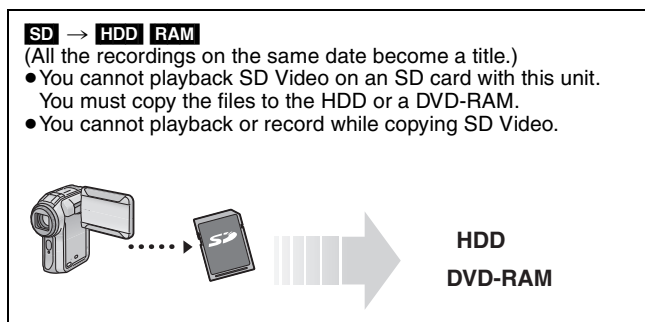

1 Insert a card.

e.g.,

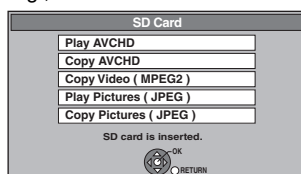

- If there are no SD Video on an SD card, “Copy Video (MPEG2)” is not displayed.

2 Press [▲, ▼] to select “Copy Video (MPEG2)” and press [OK].

3 Go to step 8 on page 52.

How to copy

Refer to “Copying using the copying list—Advanced Copy” (⇒ 52)

Please set the items in step 4 and 5 as shown below.

Copy Direction:
Source :SD CARD

Copy Mode:
Format :VIDEO

- SD Video on an SD card are automatically registered on the copy list.

■ From a video equipment

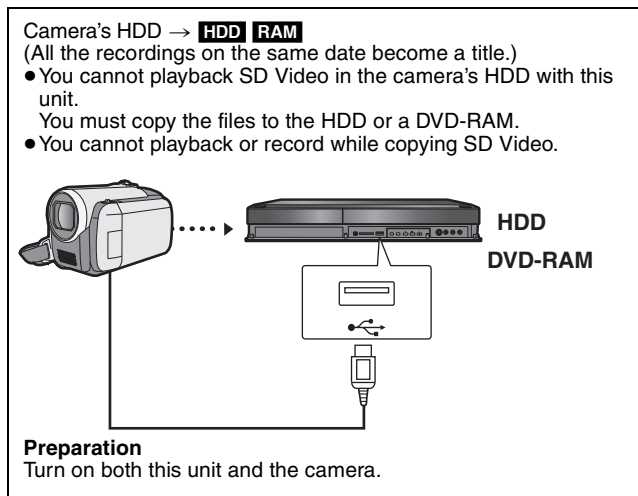

1 Connect the camera to this unit.

2 Select the appropriate mode that makes the camera ready for data transfer (such as “PC CONNECT”) on the camera.

- Refer to the camera's operating instructions for detail.

e.g.,

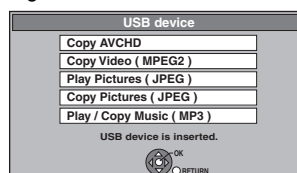

- If there are no SD Video on the camera, “Copy Video (MPEG2)” is not displayed.

3 Press [▲, ▼] to select “Copy Video (MPEG2)” and press [OK].

4 Go to step 8 on page 52.

How to copy

Refer to “Copying using the copying list—Advanced Copy” (⇒ 52)

Please set the items in step 4 and 5 as shown below.

Copy Direction:
Source :USB

Copy Mode:
Format :VIDEO

- SD Video on the camera are automatically registered on the copy list.

HDD BD-RE RAM CD USB SD

- You can play still pictures recorded with a computer onto a CD-R/CD-RW and USB memory.
- You cannot play still pictures while recording or copying.

Preparation

- Insert a disc, card, or USB memory.
- Press [DRIVE SELECT] to select the drive.

The display below automatically appears when you insert a SD card, USB memory, or the CD while stopped.

Press [\blacktriangle , \blacktriangledown] to select "Play Pictures (JPEG)" or "JPEG" and press [OK].

Then go to step 3 (\Rightarrow right).

- **CD** It will go to step 3 (\Rightarrow right) automatically if it is only still pictures that is recorded.

e.g.,

SD

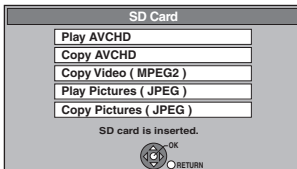

USB

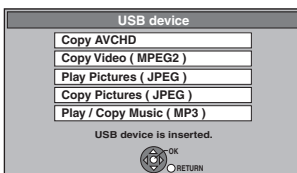

CD

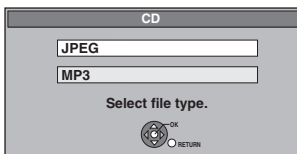

- Display contents differs depending on what is recorded in each media.

1 Press [DIRECT NAVIGATOR].

HDD BD-RE RAM

When "PICTURE" is not selected, press the "Green" button to select "PICTURE".

HDD BD-RE RAM

To switch the display method

Still pictures copied from SD cards and USB memories are grouped by the shooting date in the HDD, BD-RE or DVD-RAM.

You can arrange these still pictures and create an album (\Rightarrow 62).

- 1 Press [OPTION].
- 2 Press [\blacktriangle , \blacktriangledown] to select "Album View" or "Pictures by Date" and press [OK].

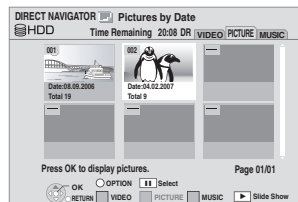

Pictures by Date screen

- **CD SD** "Picture (JPEG) View" is displayed. (\Rightarrow go to step 3).

Direct Navigator screen icons

- Picture and Album protected.
- Date that has not yet been viewed (Only still pictures copied with "Copy All Pictures" or "Copy New Pictures")

To show other pages

Press [\blacktriangleleft , \blacktriangleright].

2

HDD BD-RE RAM

Press [\blacktriangle , \blacktriangledown , \blacktriangleleft , \blacktriangleright] to select the album or date and press [OK].

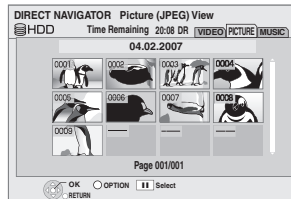

e.g., HDD

3 Press [\blacktriangle , \blacktriangledown , \blacktriangleleft , \blacktriangleright] to select the still picture and press [OK].

- Press [\blacktriangleleft , \blacktriangleright] to display the previous or next still picture.
- Useful functions during still picture play (\Rightarrow 61)

To return to previous screen

Press [RETURN].

To exit the screen

Press [DIRECT NAVIGATOR].

Useful functions during still picture play

Start Slide Show

Slide Show Setting

You can display still pictures one by one at a constant interval.

1 **HDD** **BD-RE** **RAM** Press [**▲**, **▼**, **◀**, **▶**] to select the album or date.

2 Press [**OPTION**].

• **HDD** **BD-RE** **RAM** Slide show will start by pressing [**▶**] (PLAY).

3 Press [**▲**, **▼**] to select “Start Slide Show” and press [**OK**].

• **To change the display interval**

1 Press [**▲**, **▼**] to select “Slide Show Setting” in step 3 and press [**OK**].

2 Press [**▲**, **▼**] to select “Display interval”.

3 Press [**◀**, **▶**] to select the desired interval.

4 Press [**▲**, **▼**, **◀**, **▶**] to select “Set” and press [**OK**].

• **Repeat Play**

1 Press [**▲**, **▼**] to select “Slide Show Setting” in step 3 and press [**OK**].

2 Press [**▲**, **▼**] to select “Repeat Play”.

3 Press [**◀**, **▶**] to select “On” or “Off”.

4 Press [**▲**, **▼**, **◀**, **▶**] to select “Set” and press [**OK**].

• **HDD** **BD-RE** **RAM** **SD** **Playback the music**

Sample music in this unit or music stored on the HDD (My Favourite or Playlist) can be played during the playback of the slide show.

1 Press [**▲**, **▼**] to select “Slide Show Setting” in step 3 and press [**OK**].

2 Press [**▲**, **▼**] to select “Soundtrack”.

3 Press [**◀**, **▶**] to select “On”.

4 Press [**▲**, **▼**, **◀**, **▶**] to select “Set” and press [**OK**].

• **HDD** **BD-RE** **RAM** **SD** **Change the music to playback**

1 Press [**▲**, **▼**] to select “Slide Show Setting” in step 3 and press [**OK**].

2 Press [**▲**, **▼**] to select “Select Soundtrack” and press [**OK**].

3 Press [**▲**, **▼**] to select the music playlist and press [**OK**].

4 Press [**▲**, **▼**, **◀**, **▶**] to select “Set” and press [**OK**].

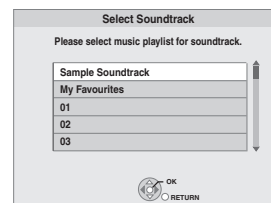

To end the slide show

Press [**RETURN**].

Rotate

While playing

1 Press [**OPTION**].

2 Press [**▲**, **▼**] to select “Rotate RIGHT” or “Rotate LEFT” and press [**OK**].

• Rotation information will not be stored.

- **CD** **USB** Still pictures
- When disc or card is protected
- When played on other equipment
- When copying pictures
- When changing date

• If you remove the SD card while the DIRECT NAVIGATOR screen is displayed, picture rotation information may not be properly stored. Remove the SD card after you exit the DIRECT NAVIGATOR screen.

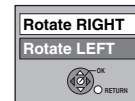

Zoom in Zoom out

While playing

1 Press [**OPTION**].

2 Press [**▲**, **▼**] to select “Zoom out” and press [**OK**].

• Press [**▲**, **▼**] to select “Zoom in” in step 2 and press [**OK**] to resume the display size of the still picture.

• When zooming in, the picture may be cut off.

• The zoom out information will not be stored.

• This function is only available for small-sized still pictures.

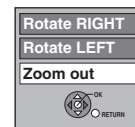

Properties

While playing

Press [**STATUS** ⓘ] twice.

e.g., HDD

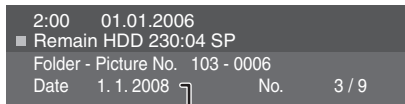

To exit the picture properties screen

Press [**STATUS** ⓘ].

Shooting date

Switch the folder

BD-RE **RAM** (Only when there is another compatible folder in upper level folder when displaying Album View screen)
Switch the upper level folder

While the Album View screen is displayed

1 Press [**OPTION**].

2 Press [**▲**, **▼**] to select “Select Folder” and press [**OK**].

3 Press [**◀**, **▶**] to select the folder and press [**OK**].

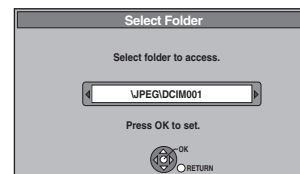

CD

While the Picture (JPEG) View screen is displayed

1 Press [**OPTION**].

2 Press [**▲**, **▼**] to select “Select Folder” and press [**OK**].

3 Press [**▲**, **▼**, **◀**, **▶**] to select the folder and press [**OK**].

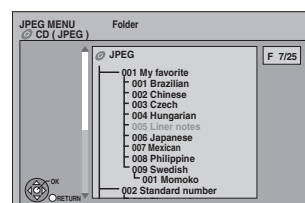

Editing still pictures (JPEG)

HDD BD-RE RAM SD

- Editing can be done in units of pictures, albums, or dates.
- You cannot edit still pictures recorded on CD-R/CD-RW and USB memory.

Preparation

- Press [DRIVE SELECT] to select the drive.
- **BD-RE RAM SD** Release protection (→ 11, 79, Setting the protection).

1 Press [DIRECT NAVIGATOR].

HDD BD-RE RAM

When "PICTURE" is not selected, press the "Green" button to select "PICTURE".

HDD BD-RE RAM

To switch the display method

- 1 Press [OPTION].
- 2 Press [▲, ▼] to select "Album View" or "Pictures by Date" and press [OK].

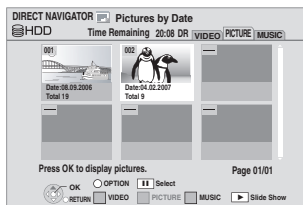

Pictures by Date screen

SD "Picture (JPEG) View" is displayed. (→ go to step 2, Editing a still picture).

2 Editing an album or date:

Select the album or date to be edited and press [OPTION].

Editing a still picture:

- 1 Select the album or date which contains the still picture to edit and press [OK].

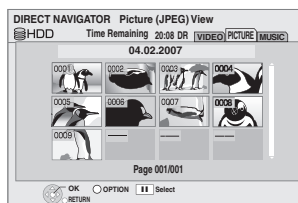

e.g., HDD

- 2 Select the still pictures to edit and press [OPTION].

To show other pages

Press [◀, ▶].

Multiple editing

Select with [▲, ▼, ◀, ▶] and press [■]. (Repeat.) A check mark appears. Press [■] again to cancel.

3 Press [▲, ▼] to select the operation and press [OK].

(e.g., **HDD** Pictures by Date)

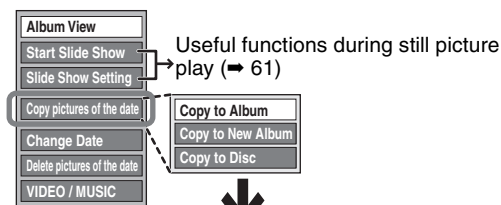

Still pictures operation (→ 63)

(e.g., **HDD** Album View)

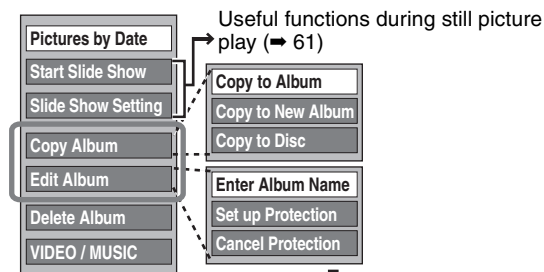

Still pictures operation (→ 63)

(e.g., **HDD** Picture (JPEG) View)

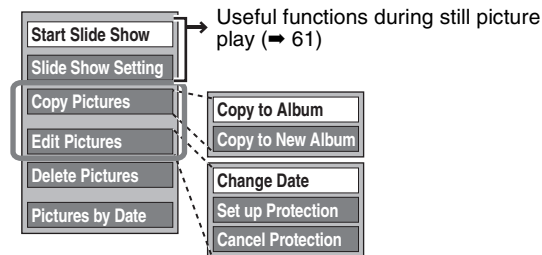

Still pictures operation (→ 63)

(e.g., **SD**)

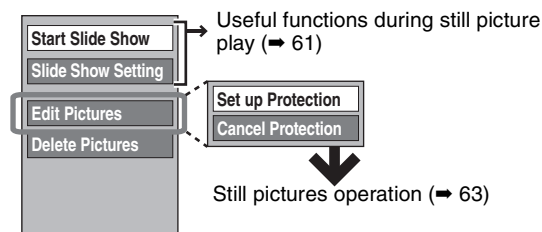

Still pictures operation (→ 63)

To return to the previous screen

Press [RETURN].

To exit the screen

Press [DIRECT NAVIGATOR].

Still pictures operation

After performing steps 1–3 (➔ 62)

Copy to Album [*] HDD BD-RE RAM	Copy the selected album, date, or pictures to an existing album. ① Press [◀ , ▶] to select “Start” and press [OK]. ② Press [▲ , ▼ , ◀ , ▶] to select the destination album and press [OK]. • The destination album with protect setting cannot be copied to.
Copy to New Album [*] HDD BD-RE RAM	Copy the selected album, date, or pictures to new album. ① Press [◀ , ▶] to select “Start” and press [OK]. ② Press [OK]. ③ Press [◀ , ▶] to select “Yes” or “No” and press [OK]. • If “Yes” is selected: You can give names to albums. (➔ 73, Entering text) • If “No” is selected: Date of the first recorded picture in the album becomes the album name automatically. (If there is no information about the recording date, it will become “--.--.--.”)
Copy to Disc HDD Copy to HDD BD-RE RAM	Press [◀ , ▶] to select “Start” and press [OK].
Change Date [*] HDD BD-RE RAM (Pictures by Date only)	① Press [◀ , ▶] to select the item and press [▲ , ▼] to change. ② Press [OK]. • Date of the original is maintained. Delete if unrequired. • If the changed date already exists, pictures will be moved to that date.
Enter Album Name HDD BD-RE RAM (Album View only)	You can give names to albums. (➔ 73, Entering text) • Album names input using this unit may not be displayed on other equipment.
Set up Protection [*] Cancel Protection [*]	If set, this will protect the still picture or album from accidental deletion. Press [◀ , ▶] to select “Yes” and press [OK]. The lock symbol appears when the still picture or album is protected. • Even if the protection setting is used by this unit to protect an album, the album may be deleted by another unit.
Delete Pictures of the date [*] Delete Album [*] Delete Pictures [*]	Press [◀ , ▶] to select “Delete” and press [OK]. • Once deleted, the recorded contents are lost and cannot be restored. Make certain before proceeding. • BD-RE RAM If there is a file other than DCF format or other folder exists in the date or album, only the pictures will be deleted, and the date or the album itself will not be deleted.

* Multiple editing is possible.

[Copy to Album, Copy to New Album, Change Date : Only when the “Picture (JPEG) View” screen is displayed]

Note

- Timer recordings do not start when performing “Copy to Album”, “Copy to New Album”, “Change Date”, “Copy to Disc” or “Copy to HDD”.

Copying still pictures

HDD **BD-RE** **RAM** **USB** **SD**

- Pictures copied from SD card and USB memory will be categorised according to the shooting date. Pictures without shooting date will be categorised using the creation date.
- You cannot copy pictures recorded to CD-R/CD-RW.
- If the space on the destination drive runs out or the number of files/folders to be copied exceeds the maximum (→ 113), copying will stop partway through.
- You cannot copy the information about the picture rotation.
- Timer recording will not start while copying still pictures.

Copying all the still pictures on the USB memory—Copy All Pictures

USB → **HDD**

- 1 While stopped**
Insert the USB memory.
The menu is automatically displayed.

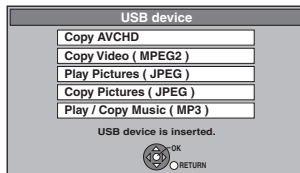

- 2 Press [▲, ▼] to select “Copy Pictures (JPEG)” and press [OK].**

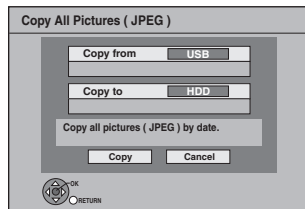

- 3 Press [◀, ▶] to select “Copy” and press [OK].**

- will be displayed on the Pictures by Date screen of the Direct Navigator for the added pictures.

To stop copying
Press and hold [RETURN] for 3 seconds.

- Note**
- The structure of folders on the USB memory may not be the same as the copy destination.

Copying new still pictures on the SD card—Copy New Pictures

SD → **HDD**

This unit saves information about imported still pictures. Therefore, if still pictures are imported from the same SD card, then only new still pictures will be imported.

- 1 While stopped**
Insert the SD card.
The menu is automatically displayed.

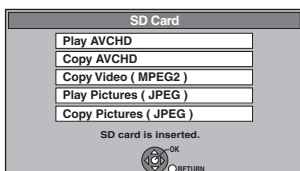

- 2 Press [▲, ▼] to select “Copy Pictures (JPEG)” and press [OK].**

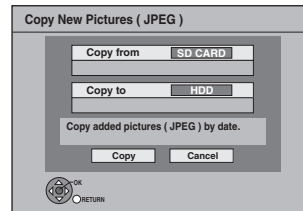

- 3 Press [◀, ▶] to select “Copy” and press [OK].**

- Protection of the card is
 - Set: Copy will start
 - Not set: Go to step 4

- 4 Press [◀, ▶] to select “Yes” or “No” and press [OK].**

- If “Yes” is selected
Copied pictures in the SD card will be deleted after copying.
- If “No” is selected
Pictures will not be deleted.

- will be displayed on the Pictures by Date screen of the Direct Navigator for the added pictures.

To stop copying
Press and hold [RETURN] for 3 seconds.

- Note**
- This unit saves the information on up to 12,000 still pictures and 30 SD cards. If additional still pictures are imported, then the older information will be deleted.

Copying using the copying list

HDD **BD-RE** **RAM** **SD**

- 1 While stopped**
Press [FUNCTION MENU].
- 2 Press [▲, ▼] to select “To Others” and press [OK].**
- 3 Press [▲, ▼] to select “Advanced Copy” and press [OK].**

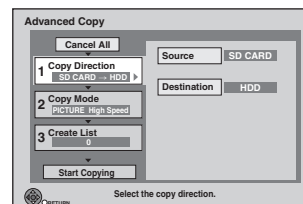

- If you are not going to change the registered list press [▼] several times (→ step 7).

- 4 Set the copy direction.**

- If you are not going to change the copying direction, press [▼] (→ step 5).
 - ① Press [▲, ▼] to select “Copy Direction” and press [▶].
 - ② Press [▲, ▼] to select “Source” and press [OK].
 - ③ Press [▲, ▼] to select the drive and press [OK].
 - ④ Press [▲, ▼] to select “Destination” and press [OK].
 - ⑤ Press [▲, ▼] to select the drive and press [OK].
The same drive as the copy source cannot be copied.
 - ⑥ Press [◀] to confirm.

- 5 Set the copy mode.**

- If you are not going to change the recording mode, press [▼] (→ step 6).
 - ① Press [▲, ▼] to select “Copy Mode” and press [▶].
 - ② Press [▲, ▼] to select “Format” and press [OK].
 - ③ Press [▲, ▼] to select “PICTURE” and press [OK].
“Recording Mode” is automatically set to “High Speed”.
 - ④ Press [◀] to confirm.

6 Register still pictures for copy.

- If you are going to copy a registered list without making any changes to it (⇒ step 7).
- Pictures from different dates or albums will not be registered to same list.

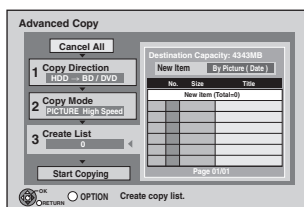

■ Select the units to register **HDD** **BD-RE** **RAM**

- 1 Press [▲, ▼] to select “Create List” and press [▶].
- 2 Press [▲, ▼] to select “New Item” and press [OK].



- 3 Press [▲, ▼] to select the item and press [OK].

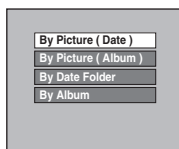

- **SD** Selection of units to register cannot be done. It can only be registered in picture units.

Register with By Picture (Date/Album)

- 1 Press [▲, ▼] to select “New item” and press [OK].
- 2 Press [▲, ▼, ◀, ▶] to select the still picture and press [■].
A check mark is displayed. Repeat this step until you select all necessary items.
 - Press [■] again to cancel.
 - The items will be copied in the order of the copying list. If you want to specify the order, repeat selecting one item at a time.
 - To select another folder (⇒ right)
- 3 Press [OK].
 - To edit the copying list (⇒ right)
- 4 Press [◀] to confirm.

Register with By Date Folder/By Album

- 1 Press [▲, ▼] to select “New item” and press [OK].
- 2 Press [▲, ▼, ◀, ▶] to select the folder and press [■].
A check mark is displayed. Repeat this step until you select all necessary items.
 - Press [■] again to cancel.
 - The items will be copied in the order of the copying list. If you want to specify the order, repeat selecting one item at a time.
 - **BD-RE** **RAM** Switch the upper level folder (⇒ 61)
- 3 Press [OK].
 - To edit the copying list (⇒ right)
- 4 Press [◀] to confirm.

7 Press [▲, ▼] to select “Start Copying” and press [OK].

- [Only when copied with “By Picture (Album)” from **HDD** to **BD-RE** **RAM**, or from **BD-RE** **RAM** to **HDD**] When specifying another album as the copying destination, select “Albums”.



8 Press [◀, ▶] to select “Yes” and press [OK] to start copying.

To stop copying

Press and hold [RETURN] for 3 seconds.

To return to the previous screen

Press [RETURN].

Note

- The sequence in which the still pictures are registered on the copy list may not be the same at the copy destination.
- If still pictures are already contained inside the copy destination folder, the new still pictures are recorded following the existing still pictures.

To show other pages

- Press [◀, ▶].

■ To edit the copying list

Select the item in step 6–3 (⇒ left)

- 1 Press [OPTION].
- 2 Press [▲, ▼] to select the operation and press [OK].

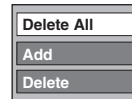

Delete All:

Delete all items registered on the copying list.
Press [◀, ▶] to select “Yes” and press [OK].

Add:

Add new items to the copying list.

- 1 Press [▲, ▼, ◀, ▶] to select the item and press [■].
A check mark is displayed. Repeat this step until you select all necessary items.
 - Press [■] again to cancel.
- 2 Press [OK].

Delete:

Delete the selected items.

Press [◀, ▶] to select “Yes” and press [OK].

To cancel all registered copying settings and lists

After performing step 1–3 (⇒ 64, Copying using the copying list)

- 1 Press [▲, ▼, ◀, ▶] to select “Cancel All” and press [OK].
 - 2 Press [◀, ▶] to select “Yes” and press [OK].
- The settings and lists may be cancelled in the following situations.
 - When a title or still picture has been recorded or deleted at the copy source
 - When steps have been taken, for instance, to turn off the unit, remove the card, open the tray, change the copy direction, etc.

■ To select another folder

After performing step 6–2 (⇒ left, Register with By Picture (Date/Album))

- 1 Press [OPTION].
- 2 Press [OK].
- 3 Press [▲, ▼, ◀, ▶] to select the folder and press [OK].
 - **BD-RE** **RAM** Switch the upper level folder (⇒ 61)

- The still pictures of different folders cannot be registered on the same list.

Playing MP3 files

CD USB

You can play MP3 files recorded with a computer onto a CD-R/CD-RW and USB memory.

- You cannot play MP3 files on the USB memory while copying.

1 Insert a disc or USB memory.

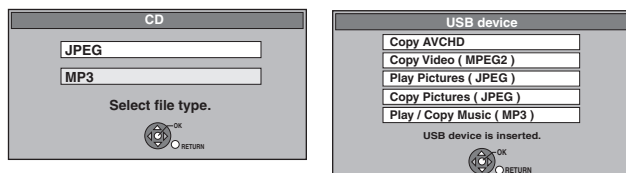

- **CD** Playback will automatically start if only MP3 is recorded.

2 Press [▲, ▼] to select “MP3” or “Play/ Copy Music (MP3)” and press [OK].

- Playback will automatically start.

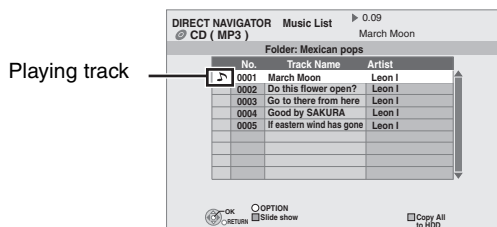

Playing different track

Press [▲, ▼] to select the track and press [OK].

To exit the screen

Press [DIRECT NAVIGATOR].
Playback of track will stop.

Using the tree screen to find a group

CD USB

- 1 While the Music list is displayed Press [OPTION].
- 2 Press [OK].

Selected group No. /Total groups

If the group has no track, “-” is displayed as group number.

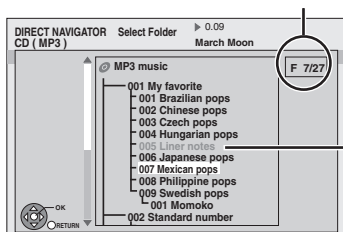

You cannot select groups that contain no compatible files.

3 Press [▲, ▼, ◀, ▶] to select a group and press [OK].

The Music list for the group appears.

To return to the previous screen

Press [RETURN].

Playing music CD

Insert a music CD.

The unit starts accessing the Gracenote® Database (→ 71) and searches for the title information.



If search results indicate that multiple titles were found Press [▲, ▼] to select the appropriate title and press [OK].

- Playback will automatically start.

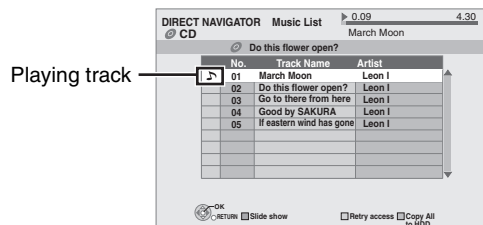

Playing different track

Press [▲, ▼] to select the track and press [OK].

Reacquire the CD title

Press the “Yellow” button.

To exit the screen

Press [DIRECT NAVIGATOR].
Playback of track will stop.

Playing music recorded on HDD

Copying music to HDD (⇒ 71)

Preparation

Press [DRIVE SELECT] to select the HDD drive.

1 Press [DIRECT NAVIGATOR].

When “MUSIC” is not selected, press the “Yellow” button to select “MUSIC”.



2 Press [▲, ▼] to select the item and press [OK].

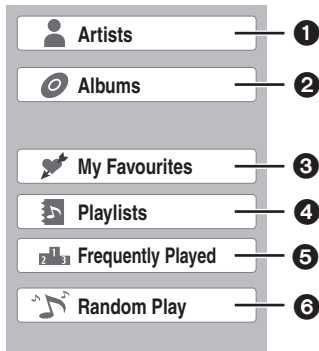

- ① Categorise by artist
- ② Categorise by album
- ③ Tracks registered in “My Favourites”
- ④ Tracks registered in “Playlists”
- ⑤ Tracks played most within 200 tracks played recently (up to 30 Tracks)
- ⑥ Random playback of all tracks

■When “Artists” is selected

- ① Press [◀, ▶] to select the initial of the artist.
- ② Press [▲, ▼] to select the name of the artist, and press [OK].
- ③ Press [▲, ▼] to select the album.

■When “Albums” is selected

- ① Press [◀, ▶] to select the initial of the album.
- ② Press [▲, ▼] to select the album.

3 Press [▲, ▼] to select the track and press [OK].

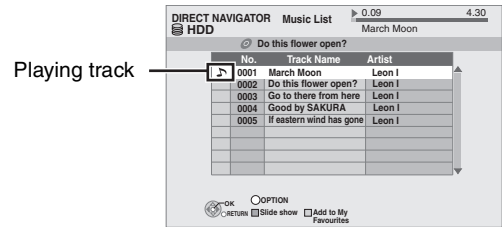

Playing different track

Press [▲, ▼] to select the track and press [OK].

To return to the previous screen

Press [RETURN].

To exit the screen

Press [DIRECT NAVIGATOR].
Playback of track will stop.

Note

- You cannot play music tracks on HDD while copying.
- When this unit is not operated for approximately 10 minutes during music playback, the screen saver is displayed [only when the “Screen Saver” in the Setup menu is set to “On” (⇒ 86)]. To return to the previous screen, press [RETURN].

Useful functions during music play

Operations during play

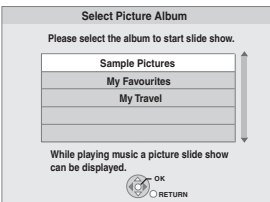
Stop	Press [■].
Pause	Press [⏸]. Press [⏸] again or [▶] (PLAY) to restart play.
Search	Press [◀◀] or [▶▶]. Press [▶] (PLAY) to restart play.
Skip	During play or while paused, press [◀◀] or [▶▶]. Skip to the track you want to play. ● Each press increases the number of skips.
Register a track to the "My Favourites" HDD	While Music list screen is displayed Press [▲, ▼] to select the track and press the "Green" button. ● Up to 99 tracks can be registered.
Properties HDD	While Music list screen is displayed 1 Press [OPTION]. 2 Press [▲, ▼] to select "Properties" and press [OK]. ● To exit the Properties screen, press [OK].
Repeat Play Random	1 Press [DISPLAY]. 2 Press [▲, ▼] to select "Play" and press [▶]. 3 Press [▲, ▼] to select "Repeat Play" or "Random" and press [▶]. 4 Press [▲, ▼] to select the item. ● Repeat Play "All": Repeatedly playback the selected album, etc. "Track": Repeatedly playback the selected track ● Random "On": Randomly playback the selected album, etc. "Off"
Re-master	This feature gives you a more natural sound by adding higher frequency signals not recorded on the track. 1 Press [DISPLAY]. 2 Press [▲, ▼] to select "Sound" and press [▶]. 3 Press [▲, ▼] to select "Sound Effects" and press [▶]. 4 Press [▲, ▼] to select "Re-master1" or "Re-master2". ● "V.Surround1" or "V.Surround2" is displayed, but there is no effect even if it is set. ● This function is effective for audio from the HDMI terminal or the DIGITAL AUDIO OUT terminal only when "Digital Audio Output" is set to "PCM". (However, in this case, audio is output as 2ch from the DIGITAL AUDIO OUT terminal.)
Display Still Pictures (Slide show)	Sample pictures in this unit or pictures stored on the "Album View" of the HDD can be played back as slide show during playback of the music. While playing the music Press the "Red" button. Change the pictures to display 1 Press [OPTION]. 2 Press [▲, ▼] to select "Select Picture Album" and press [OK]. 3 Press [▲, ▼] to select the album and press [OK].  To end the slide show Press [RETURN]. ● It will also end when the music is stopped.
Playing music continuously even after turning off power to the television	When the unit is connected to a Panasonic TV (VIERA) that supports HDAVI Control 2 or HDAVI Control 3 and an amplifier/receiver supports HDAVI Control, the unit is turned off if the power to the television is turned off, since "Power off link" (⇒ 74) operates. The following operations make it possible to keep the power of the unit ON and to play music continuously. ① While playing music Press [OPTION]. ② Press [▲, ▼] to select "TV Power Off" and press [OK]. ● Sound may be discontinued for several seconds when the power to the television is turned off. ● If the operation mentioned above is executed while audio is output from the television, the sound may not be output from the amplifier/receiver. It is recommended to set the amplifier/receiver beforehand so that audio will be output from the amplifier/receiver.

Editing music

HDD

Preparation

Press [DRIVE SELECT] to select the HDD drive.

1 Press [DIRECT NAVIGATOR].

When "MUSIC" is not selected, press the "Yellow" button to select "MUSIC".

- When doing "Delete All Tracks", "Clear My Favourites" or "Clear Frequently Played" (⇒ go to step 3)

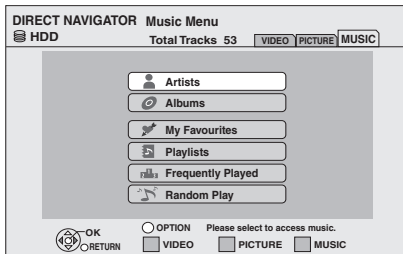

2 Press [▲, ▼] to select item and press [OK].

■ When "Artists" is selected

- 1 Press [◀, ▶] to select the initial of the artist.
- 2 Press [▲, ▼] to select the name of the artist, and press [OK].
- 3 Press [▲, ▼] to select the album.
 - To edit the track, press [OK], and select the track with [▲, ▼].

■ When "Albums" is selected

- 1 Press [◀, ▶] to select the initial of the album.
- 2 Press [▲, ▼] to select the album.
 - To edit the track, press [OK], and select the track with [▲, ▼].

3 Press [OPTION].

4 Press [▲, ▼] to select item and press [OK].

e.g., while selecting album

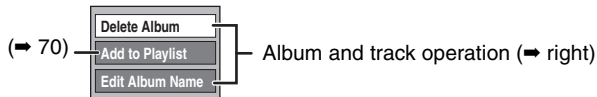

e.g., while selecting artist

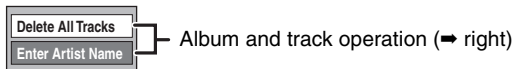

e.g., while selecting track

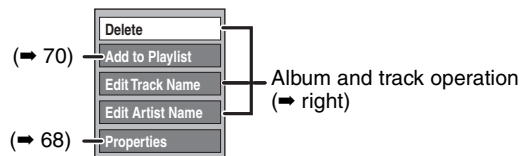

To return to the previous screen

Press [RETURN].

To exit the screen

Press [DIRECT NAVIGATOR].

Album and track operation

After performing step 1–4 (⇒ left)

Delete All Tracks

- While displaying Music Menu screen

Delete all tracks in the HDD.

- 1 Press [◀, ▶] to select "Yes" and press [OK].
 - 2 Press [◀, ▶] to select "Delete" and press [OK].
- Once deleted, the recorded contents are lost and cannot be restored. Make certain before proceeding.

Delete All Tracks

- While displaying "Artists" screen

Delete Album

- While displaying "Albums" screen

Delete

All tracks in the selected Artist or Album are deleted in case of "Delete All Tracks" or "Delete Album". Press [◀, ▶] to select "Delete" and press [OK].

- Once deleted, the recorded contents are lost and cannot be restored. Make certain before proceeding.

Edit Album Name

(⇒ 73, Entering text)

Edit Track Name

Edit Artist Name

Enter Artist Name

Clear My Favourites

Remove all tracks in "My Favourites". Tracks themselves are not deleted from the HDD. Press [◀, ▶] to select "Clear" and press [OK].

Clear Frequently Played

Remove all tracks in "Frequently Played". Tracks themselves are not deleted from the HDD. Press [◀, ▶] to select "Clear" and press [OK].

Remove

- While displaying "My Favourites" or "Frequently Played" screen

Selected track is removed. Track itself is not deleted from the HDD. Press [◀, ▶] to select "Remove" and press [OK].

Register track to Playlist

HDD

You can register your favourite albums and tracks into 10 preset playlists.

- Name of the playlist can be changed.
- New playlist cannot be added.
- Up to 999 tracks can be registered to each playlist.

Preparation

Press [DRIVE SELECT] to select the HDD drive.

1 Press [DIRECT NAVIGATOR].

When "MUSIC" is not selected, press the "Yellow" button to select "MUSIC".

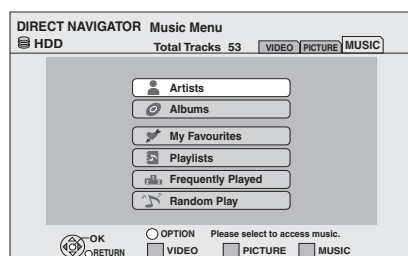

2 Press [▲, ▼] to select item and press [OK].

■When "Artists" is selected

- ① Press [◀, ▶] to select the initial of the artist.
- ② Press [▲, ▼] to select the name of the artist, and press [OK].
- ③ Press [▲, ▼] to select the album.
 - To register the track, press [OK], and select the track with [▲, ▼].

■When "Albums" is selected

- ① Press [◀, ▶] to select the initial of the album.
- ② Press [▲, ▼] to select the album.
 - To register the track, press [OK], and select the track with [▲, ▼].

3 Press [OPTION].

4 Press [▲, ▼] to select "Add to Playlist" and press [OK].

5 Press [▲, ▼] and select the playlist to register, and press [OK].

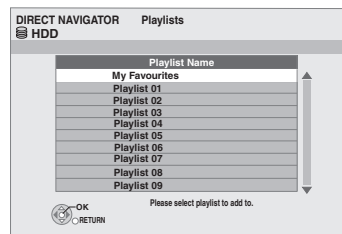

To return to the previous screen

Press [RETURN].

To exit the screen

Press [DIRECT NAVIGATOR].

Editing Playlist

HDD

1 Press [DIRECT NAVIGATOR].

When "MUSIC" is not selected, press the "Yellow" button to select "MUSIC".

2 Press [▲, ▼] to select "Playlists" and press [OK].

3 Edit the playlist Press [▲, ▼] to select the playlist and press [OPTION].

Edit the track in the playlist

- ① Press [▲, ▼] to select the playlist and press [OK].
- ② Press [▲, ▼] to select the track and press [OPTION].

4 Press [▲, ▼] to select item and press [OK].

e.g., while selecting playlist

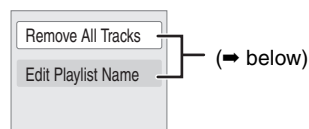

e.g., while selecting the track in playlist

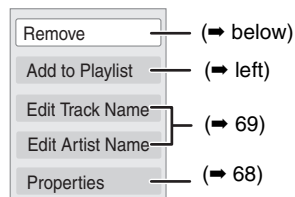

To return to the previous screen

Press [RETURN].

To exit the screen

Press [DIRECT NAVIGATOR].

Playlist operation

After performing step 1-4 (=> above, Editing Playlist)

Remove All Tracks	Remove all tracks in the selected playlist. Tracks themselves are not deleted from the HDD. Press [◀, ▶] to select "Remove" and press [OK].
Remove	Selected track is removed. Track itself is not deleted from the HDD. Press [◀, ▶] to select "Remove" and press [OK].
Edit Playlist Name	(=> 73, Entering text)

Copying music to HDD

You can store the two formats of music data in this unit's HDD.

Music CD (CD-DA)

When inserting music CDs, this unit makes access to the internal Gracenote® Database to obtain title information. The album name, track name and artist name are assigned automatically allowing you find the track easily when playing back.

MP3

You can copy MP3 files from the CD or USB memory.

About the Gracenote® Database

The Gracenote® Database is a database used to search and retrieve CD title information.

When a CD is inserted, the unit will automatically search for and obtain information about the inserted CD.

The Gracenote® Database comes pre-installed on this unit, so titles and artist information can be obtained. This unit has an internal database containing information for approximately 350,000 album titles.

If the title of the newly released CD is not in the built-in database, it is possible to acquire the title automatically by connecting to the network via the Internet. (→ 98)

If there are CDs with very similar title information, then the incorrect title information may be obtained. If no title suggestions are found, it is displayed as "Unknown Artist", "Unknown Album".

In these cases, enter the CD title information manually, after recording to the HDD has completed.

Copying music from a CD or a USB memory

CD USB → HDD

- **CD** (Music CD): All tracks in the CD will be recorded.
- **USB CD** (MP3): All tracks in the folder will be recorded. (Cannot record track-by-track.)
- It will be recorded as 1 album to the HDD in 1 recording.
- **Audio quality**
 - **CD** (Music CD): LPCM, **USB CD** (MP3): MP3
- The maximum number of tracks on HDD: 40000 (Depends on the remaining capacity.)
If titles or pictures are recorded, then the number of albums that can be recorded will be reduced.

1 While stopped

Insert a CD or USB memory.

CD (Music CD)

The unit starts accessing the Gracenote® Database and searches for the title information.



If search results indicate that multiple titles were found Press [▲, ▼] to select the appropriate title and press [OK].

USB CD (MP3)

The menu is automatically displayed.

Press [▲, ▼] to select "Play/Copy Music (MP3)" or "MP3" and press [OK].

- **CD** It will go to step 2 automatically if it is only MP3 that is recorded.

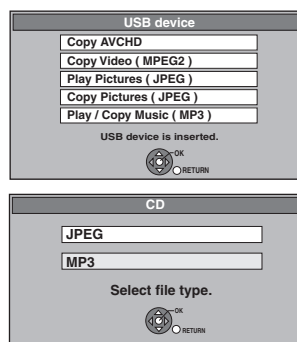

2 Press the "Blue" button.

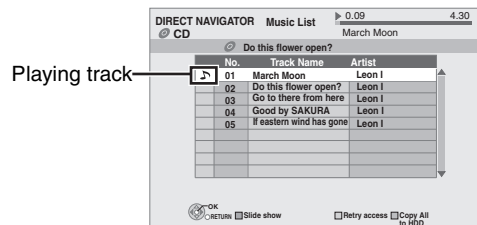

3 Press [◀, ▶] to select "Copy" and press [OK].

Recording starts.

To stop recording

Press and hold [RETURN] for 3 seconds.

To return to the previous screen

Press [RETURN].

Note

- While recording, no other operations can be performed. Timer recordings will not proceed.
- Tracks recorded on the HDD cannot be transferred to a disc, USB memory or SD card.
- CDs which have SCMS (Serial Copy Management System) restrictions cannot be recorded to the HDD.

Once deleted, the recorded contents are lost and cannot be restored. Make certain before proceeding.

Deleting still pictures

HDD **BD-RE** **RAM** **SD**

- 1 While stopped
Press [FUNCTION MENU].
- 2 Press [**▲**, **▼**] to select “Delete” and press [OK].

HDD **BD-RE** **RAM**

When “PICTURE” is not selected, press the “Green” button to select “PICTURE”

HDD **BD-RE** **RAM**

To switch the display method

- 1 Press [OPTION].
- 2 Press [**▲**, **▼**] to select “Album View” or “Pictures by Date” and press [OK].

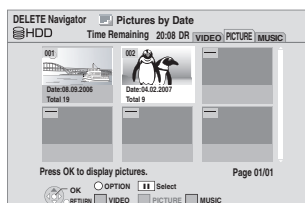

- 3 Deleting an album/date (still picture)
Press [**▲**, **▼**, **◀**, **▶**] to select the item and press [DELETE *].

Deleting a still picture

- 1 Press [**▲**, **▼**, **◀**, **▶**] to select the item which contains the still picture to delete and press [OK].
- 2 Press [**▲**, **▼**, **◀**, **▶**] to select the still picture and press [OK].

You can confirm the item that you have selected using the option menu. (⇒ 62, step 2)

To show other pages

Press [**◀◀**, **▶▶**].

Multiple deleting

Select with [**▲**, **▼**, **◀**, **▶**] and press [III]. (Repeat.) A check mark appears. Press [III] again to cancel.

- 4 Press [**◀**, **▶**] to select “Delete” and press [OK].
The item is deleted.

To return to the previous screen

Press [RETURN].

To exit the screen

Press [EXIT].

Deleting music

HDD

- 1 While stopped
Press [FUNCTION MENU].
- 2 Press [**▲**, **▼**] to select “Delete” and press [OK].

When “MUSIC” is not selected, press the “Yellow” button to select “MUSIC”.

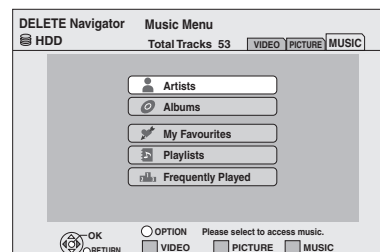

- 3 Deleting an artist/album (music)

- 1 Press [**▲**, **▼**, **◀**, **▶**] to select the item and press [OK].
- 2 Press [**▲**, **▼**, **◀**, **▶**] to select the item and press [DELETE *].

Deleting a track

- 1 Press [**▲**, **▼**, **◀**, **▶**] to select the item which contains the track to delete and press [OK].
- 2 Press [**▲**, **▼**, **◀**, **▶**] to select the track and press [OK].

Remove the music

(Only when “My Favourites”, “Playlists”, or “Frequently Played” are selected)

- 1 Press [**▲**, **▼**] to select the item and press [OK].
- 2 Press [**▲**, **▼**] to select the track and press [OK].
- 3 Press [**◀**, **▶**] to select “Remove” and press [OK].
 - Remove is executed. (There is no need to proceed to step 4)
 - Track itself is not deleted from the HDD.

You can confirm the item that you have selected using the option menu. (⇒ 69, step 3)

- 4 Press [**◀**, **▶**] to select “Delete” and press [OK].
The item is deleted.

To return to the previous screen

Press [RETURN].

To exit the screen

Press [EXIT].

Entering text

HDD **BD-RE** **BD-R** **RAM** **-R** **-R DL** **-RW(V)** **+R** **+R DL** **+RW**

You can give names to recorded titles, etc.

The maximum number of characters:

HDD BD-RE BD-R RAM	Characters
Title (HDD RAM)	64 (44*)
Title (BD-RE BD-R)	254 (44*)
Album of still pictures (HDD BD-RE RAM)	36
Album (Music) (HDD)	59
Track (HDD)	59
Artist (HDD)	39
Playlist (Music) HDD	59
Disc (BD-RE BD-R)	254
Disc (RAM)	64

*Title name for timer recording

-R -R DL -RW(V) +R +R DL +RW	Characters
Title	44
Disc	40

Note

If a name is long, parts of it may not be shown in some screens.

1 Show Enter Name screen.

Title (timer recording)

Select "Programme Name" in step 3 on page 34.

Title

Select "Enter Name" in step 4 on page 44.

Disc

Select "Disc Name" in step 1 of "Providing a name for a disc" on page 79.

Album of still pictures

Select "Enter Album Name" in step 3, "Editing still pictures (JPEG)" on page 62.

Album (Music) (**HDD**)

Select "Edit Album Name" in step 4 of "Editing music" on page 69.

Track (**HDD**)

Select "Edit Track Name" in step 4 of "Editing music" on page 69.

Artist (**HDD**)

Select "Edit Artist Name" in step 4 of "Editing music" on page 69.

Playlist (Music) (**HDD**)

Select "Edit Playlist Name" in step 4 of "Editing Playlist" on page 70.

Name field: shows the text you have entered

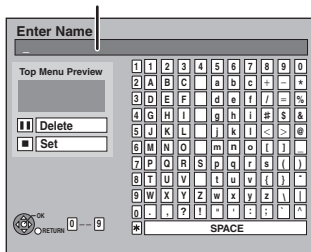

2 Press [**▲**, **▼**, **◀**, **▶**] to select a character and press [OK].

Repeat this step to enter other characters.

• To delete a character

Press [**▲**, **▼**, **◀**, **▶**] to select the character in the name field and press [**III**]. (The selected characters are deleted.)

• Using the numbered buttons to enter characters

e.g., entering the letter "R"

① Press [7] to move to the 7th row.

② Press [7] twice to highlight "R".

③ Press [OK].

• To enter a space

Press [DELETE *] and press [OK].

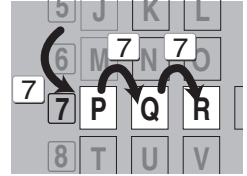

3 Press [**■**] (Set).

"Writing..." appears then the screen returns to the Title view screen and so on.

To end partway

Press [RETURN].

Text is not added.

For your reference

If you enter a long name, only part of it is shown in the Top Menu after finalisation (→ 81). When entering a title name, the name that will appear in the Top Menu can be previewed in "Top Menu Preview" window.

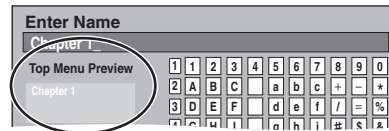

Linked operations with the TV (VIERA Link “HDAVI Control™”)

You can enjoy linked operations with the TV and receiver by using “HDAVI Control”.

What is VIERA Link “HDAVI Control”?

VIERA Link “HDAVI Control” is a convenient function that offers linked operations of this unit, and a Panasonic TV (VIERA) or receiver under “HDAVI Control”. You can use this function by connecting the equipment with the HDMI cable. See the operating instructions for connected equipment for operational details.

- VIERA Link “HDAVI Control”, based on the control functions provided by HDMI which is an industry standard known as HDMI CEC (Consumer Electronics Control), is a unique function that we have developed and added. As such, its operation with other manufacturers’ equipment that supports HDMI CEC cannot be guaranteed.
- **This unit supports “HDAVI Control 3” function.**
“HDAVI Control 3” is the newest standard (current as of December, 2007) for Panasonic’s HDAVI Control compatible equipment. This standard is compatible with Panasonic’s conventional HDAVI equipment.
- Please refer to individual manuals for other manufacturers’ equipment supporting VIERA Link function.

Preparation

- 1 Connect this unit to your TV using an HDMI cable (⇒ 17) or to your receiver using an HDMI cable (⇒ 95).
 - 2 Set “VIERA Link” to “On” (⇒ 87). (The default setting is “On”.)
 - 3 Set the “HDAVI Control” operations on the connected equipment (e.g., TV).
 - 4 Turn on all “HDAVI Control” compatible equipment and select this unit’s input channel on the connected TV so that the “HDAVI Control” function works properly.
- Also when the connection or settings are changed, repeat this procedure.**

What you can do with “HDAVI Control”

Download from the TV ^{*1}	If this unit is connected to a Panasonic TV (VIERA) supporting HDAVI Control 3 via an HDMI cable, then the setting information on the TV is acquired by this unit when the unit is turned on for the first time. (⇒ 19).
(When the TV is on) Easy playback	When the TV is on and the following operations are performed, the TV’s input will automatically switch to HDMI input mode and the TV displays the corresponding action. (Picture or sound may not be available for the first few seconds.) Press [FUNCTION MENU]^{*2}, [▶] (PLAY)^{*3}, [DIRECT NAVIGATOR], [GUIDE], [PROG/CHECK] etc.
(When the TV is off) Power on link	When the TV is off and the following operations are performed, the TV will automatically turn on and displays the corresponding action. (Picture or sound may not be available for the first few seconds.) Press [FUNCTION MENU]^{*2}, [▶] (PLAY)^{*3}, [DIRECT NAVIGATOR], [GUIDE], [PROG/CHECK] etc. ● BD-V DVD-V CD The TV is automatically turned on when you insert the discs.
Power off link	When you set the TV to standby mode, the unit is also automatically set to standby mode. The unit is automatically set to standby mode even if the FUNCTION MENU screen etc. is displayed during playback or when the unit set to a timer recording. Even if the TV is set to standby mode, the unit will not be set to standby mode at the same time when recording, copying, finalising etc. ● When this unit is connected to an “HDAVI Control” compatible Panasonic receiver with an HDMI cable, the receiver will also turn off.
Direct TV Recording ^{*1}	This function allows you to immediately start recording the programme that you are viewing on the TV. Refer to the TV operating instructions for operation. ● The titles are recorded to HDD. To stop recording Press [■]
Playing music continuously even after turning off power to the television ^{*4}	(⇒ 68, Playing music continuously even after turning off power to the television)

^{*1} This function is available with the TV which has “HDAVI Control 3” function.

^{*2} This button is available only when this unit is on.

^{*3} When this button is pressed, the playback image is not immediately displayed on the screen and it may not be possible to watch the contents from where playback started.

In this case, press [◀◀] or [◀◀] to go back to where playback started.

^{*4} This function is available with the TV which has “HDAVI Control 2” or “HDAVI Control 3” function.

Note

- These functions may not work normally depending on the equipment condition.
- About “HDAVI Control” function, read the instructions of the connected equipment (e.g., TV) too.

Easy control only with VIERA remote control

If you connect this unit to the TV that has “HDAVI Control 2” or “HDAVI Control 3” function with an HDMI cable, you can enjoy using more convenient functions.

You can operate this unit using the following buttons on the TV remote control.

[▲], [▼], [◀], [▶], [OK], [RETURN], [EXIT], [OPTION] and the coloured buttons.

Use the remote control for this unit to operate any other buttons (numbered buttons, etc.) that are not listed above.

- The operation of this unit may be interrupted when you press buttons on the TV remote control other than those listed above.
- The TV displays the TV tuner’s picture when the linked operation is finished.

Using the FUNCTION MENU window to operate this unit

- This function is available with the TV which has “HDAVI Control 2” or “HDAVI Control 3” function.

Refer to the TV operating instructions for operating the TV.

- 1 Display this unit’s “FUNCTION MENU” window using the TV remote control.**
 - If this unit is set to standby mode, it will automatically turn on.
- 2 Select the item you want to operate with the TV remote control, and press [OK].**

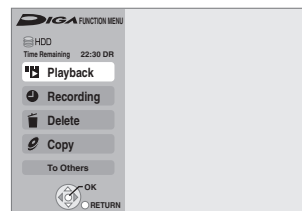

About the FUNCTION MENU window (⇒ 78).

Pause live TV programme

- This function is available with the TV which has “HDAVI Control 3” function.

You can pause the TV programme you are watching and resume later by temporarily saving it on the HDD. This is useful when you have to briefly stop watching TV to run an errand. If you stop the Pause Live TV function, then the TV programme temporarily saved on the HDD will be deleted.

Refer to the TV operating instructions for operating the TV.

- 1 When you want to pause the TV programme**
Turn on the “Pause Live TV” function using the TV remote control.
 - This unit turns on automatically.
- 2 When you want to resume**
Display the Control Panel (⇒ below) and press [OK].
 - The TV programme resumes.

To stop Pause Live TV

- ① Press [▼] while the Control Panel is displayed.
- ② Press [◀, ▶] to select “Yes” and press [OK].

Refer to “Note” on page 78, “To pause the TV programme you are watching—Pause Live TV”.

Using the OPTION menu window to operate this unit

- This function is available with the TV which has “HDAVI Control 2” or “HDAVI Control 3” function.

By using the TV remote control, you can play discs using the “Control Panel” (⇒ below).

- 1 Press [OPTION].**

e.g.,



Note

You cannot use the OPTION menu while the Top Menu for DVD-Video is displayed and while DVD-Video is copying.

- 2 Select an item then press [OK].**

Control Panel	Control Panel is displayed (⇒ below).
FUNCTION MENU	FUNCTION MENU window is displayed (⇒ above).
Aspect	Switch the screen mode (⇒ 77).
Top Menu BD-V DVD-V	Top menu is displayed (⇒ 22).
Menu DVD-V	Menu is displayed.
Pop-up Menu BD-V	Pop-up Menu is displayed. (⇒ 42)
Drive Select	Select the HDD, BD or SD drive
Rotate RIGHT (JPEG)	Rotate the still picture (⇒ 61).
Rotate LEFT (JPEG)	
Zoom in (JPEG)	Enlarge or shrink the still picture (⇒ 61).
Zoom out (JPEG)	

Using the Control Panel

Using the Control Panel, you can operate search backward, search forward, stop, etc. with the TV remote control. Perform steps 1 and 2 of “Using the OPTION menu window to operate this unit” (⇒ above).

The Control Panel is displayed (⇒ right).

- When playing a title, etc.
 - [▲]: Pause, [▼]: Stop, [◀]: Search backward, [▶]: Search forward, [OK]: Play, [EXIT]: Exit the screen.
- While playing still pictures
 - [▼]: Stop, [◀]: View previous picture, [▶]: View next picture, [EXIT]: Exit the screen.

Control Panel

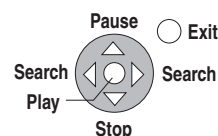

■ When you want to leave the TV on and set only this unit to standby mode

Press [⏻ BD] on this unit’s remote control and set to standby mode.

■ When not using “HDAVI Control”

Set “VIERA Link” in the Setup menu to “Off” (⇒ 87).

Using on-screen menus

Common procedures

1 Press [DISPLAY].

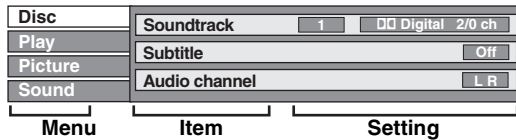

• Depending on the condition of the unit (playing, stopped, etc.) and disc contents, there are some items that you cannot select or change.

2 Press [▲, ▼] to select the menu and press [▶].

3 Press [▲, ▼] to select the item and press [▶].

4 Press [▲, ▼] to select the setting.

• Some items can be changed by pressing [OK].

To clear the on-screen menus
Press [DISPLAY].

Disc menu—Setting the disc content

Video **AVCHD**

The video recording method appears

Signal Type **BD-V**

• Primary Video

Video: The video recording method appears.
Soundtrack: Select the type of audio or language.

• Secondary Video

Video: Select on/off of images.
The video recording method appears.
Soundtrack: Select on/off of audio and the language.

Soundtrack*

HDD **BD-RE** **BD-R** **RAM** **-R** **-R DL** **-RW(V)** **+R** **+R DL** **+RW** **-RW(VR)**

The disc's audio attributes appear.

DVD-V **AVCHD**

Select the audio and language (⇒ right, Audio attribute, Language).

Subtitle*

BD-V **DVD-V** **AVCHD**

Turn the subtitle on/off and select the language (⇒ right, Language).

HDD **RAM** **-R** **-R DL** **-RW(V)** **+R** **+R DL** **+RW** **-RW(VR)**
(Only discs that contain subtitle on/off information)

Turn the subtitle on/off.

• Subtitle on/off information cannot be recorded using this unit.

Multi Audio **HDD** **BD-RE** **BD-R** (only for titles in DR mode)

Switch in the case of multiple audio.

Subtitle Style **BD-V**

Select the subtitle style recorded on the disc.

Angle* **BD-V** **DVD-V**

Change the number to select an angle.

Audio channel **HDD** **RAM** **-RW(VR)**

(⇒ 39, Changing audio during play)

* With some discs, you may only be able to make changes using the menus (⇒ 22) on the disc.

• The display changes according to the disc content. You cannot change when there is no recording.

Audio attribute

LPCM/**DD**Digital/**DD**Digital+/
DDTrueHD/DTS/DTS-HD/MPEG:

k (kHz):

b (bit):

ch (channel):

Signal type

Sampling frequency

Number of bits

Number of channels

Language

ENG: English

FRA: French

DEU: German

ITA: Italian

ESP: Spanish

NLD: Dutch

SVE: Swedish

NOR: Norwegian

DAN: Danish

POR: Portuguese

RUS: Russian

JPN: Japanese

CHI: Chinese

KOR: Korean

MAL: Malay

VIE: Vietnamese

THA: Thai

POL: Polish

CES: Czech

SLK: Slovak

HUN: Hungarian

FIN: Finnish

*: Others

Play menu—Change the play sequence

This function works only when the elapsed play time is displayed. Select the item for repeat play. Depending on the disc, the items that can be selected will differ.

Repeat Play

Items displayed depends on the contents of the playback.

- All
- Title
- Chapter
- Playlist
- Track

Select "Off" to cancel.

Random (Only when playing music)

While playing, press [▲, ▼] to select "On".

Picture menu—Change the picture quality

Mode

Select the picture quality mode during play.

- **Normal:** Default setting
- **Soft:** Soft picture with fewer video artifacts
- **Fine:** Details are sharper
- **Cinema:** Mellows movies, enhances detail in dark scenes. (This does not affect the titles in DR mode.)

HD optimizer

It will compensate the mosaic noise in the video and haze around the characters precisely.

Progressive* (⇒ 115)

Select "On" to enable progressive output.
Select "Off" if the picture is stretched horizontally.

Transfer* [When "Progressive" (⇒ above) is set to "On".]

Select the method of conversion for progressive output to suit the type of title being played (⇒ 114, Film and video).

- **Auto:** Automatically detects the film and video content, and appropriately converts it.
- **Video:** Select when using "Auto", and the content is distorted.
- **Film:** Select this if the edges of the film content appear jagged or rough when "Auto" is selected. However, if the video content is distorted as shown in the illustration to the right, then select "Auto".

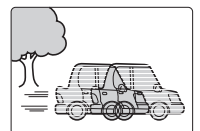

*It will work in following conditions.

– When "HDMI Video Mode" in the Setup menu is "Off" (⇒ 87) and "Component Resolution" in the Setup menu is "576p/480p" (⇒ 87)

– When "HDMI Video Mode" in the Setup menu is "Off" (⇒ 87) and playing **DVD-V**

Sound menu—Change the sound effect

Sound Effects

HDD BD-RE BD-R BD-V RAM -R -R DL -RW(V) +R +R DL
+RW DVD-V -RW(VR) CD AVCHD

- **Re-master1**
- **Re-master2**
(Discs record at 48 kHz or less)
This feature gives you a more natural sound by adding higher frequency signals not recorded on the track.
- **V.Surround1**
- **V.Surround2**
(2-channel or over only)
Enjoy a surround-like effect if you are using two front speakers only.
 - Turn V.Surround off if it causes distortion. (Check the surround function on the connected equipment.)
 - V.Surround does not work for bilingual recordings.
- This function is effective for audio from the HDMI terminal or the DIGITAL AUDIO OUT terminal only when “Digital Audio Output” is set to “PCM”. (However, in this case, audio is output as 2ch from the DIGITAL AUDIO OUT terminal.)

Dialogue Enhancer

HDD BD-RE BD-R BD-V RAM -R -R DL -RW(V) +R +R DL
+RW DVD-V -RW(VR) AVCHD

(3-channel or over only, including a centre channel)

The volume of the centre channel is raised to make dialogue easier to hear.

Status messages

Press [STATUS].

The display changes each time you press the button.

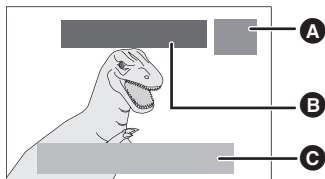

Selected drive status/type of disc or USB memory

A

HDD	Selected drive status/type of disc or USB memory
REC1	The remaining time appears while stopped.
PLAY	Recording or play status
002 ABC TV	Channel/The name of the station
022 ABC REC2	Recording in background/copy progress indicator
Audio LR eng	Selected audio type

B

Title number and elapsed time during play/
Recording mode

Date and time

Available recording time and recording mode

18:53:50 11.11.2008	
Remain HDD 45:53 DR DVD 8:27 SP	Title number and elapsed time during recording/Recording mode
T1 0:05.14 XP T2 0:10.10 DR	
T2 0:00.10 DR	
0:35:32	Current position
	Total time

- When using Pause Live TV
Current time

18:53:50 11.11.2008
Live 18:53:50
View 18:40:12

The time when the picture currently displayed on the television was broadcasted

C

1 TEN HD	10:30	All DVB Services
Coronation street		Select FAV List
9:00 - 11:00	◀ Now ▶	Software update
Rating:PG Bad Signal	STTL TEXT	I/II

Digital channel information (➔ 21)

Switch the aspect ratio of the screen

When black bars are shown at the top, bottom, left, and right sides of the screen, you can enlarge the image to fill the screen.

- 1 Press [OPTION].
- 2 Press [▲, ▼] to select “Aspect” and press [OK].
- 3 Press [◀, ▶] to select the item.

- **Normal:**
Normal output
- **Side cut:**
The black bars on the right and left sides of the 16:9 image disappear and the image is enlarged. Please note that the right and left sides of the image are cut off when the black bar is not displayed.

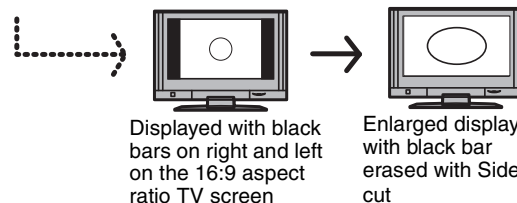
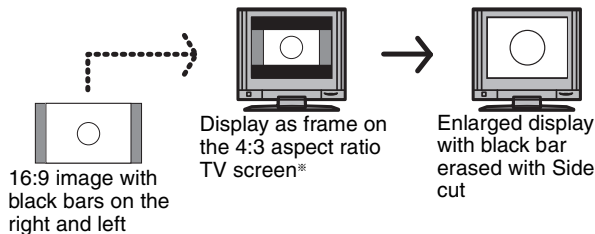

* Only when “TV Aspect” (➔ 87) is set to “Letterbox”.

- **Zoom:**
The black bars on the top and bottom sides of the 4:3 image disappear and the image is enlarged. Please note that the top and bottom sides of the image are cut off when the black bar is not displayed.

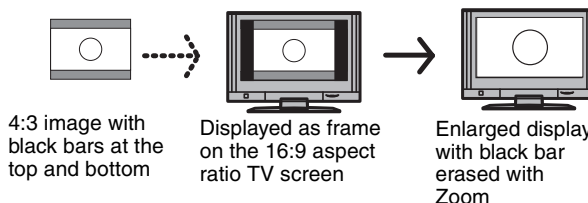

4 Press [OK].

Note

- The screen mode is switched to “Normal” in the following situations:
 - when you change channel
 - when you start or end the playback of a title
 - when the unit is turned off or on.
- **BD-V DVD-V** “Side cut” does not have any effect.
- When “TV Aspect” (➔ 87) is set to “Pan & Scan” or “Letterbox”, the “Zoom” effect is disabled.

To return to the previous screen

Press [RETURN].

To exit the screen

Press [EXIT].

FUNCTION MENU window

By using the FUNCTION MENU window you may access the main functions quickly and easily.

1 Press [FUNCTION MENU].

Functions displayed depend on the selected drive or type of disc.

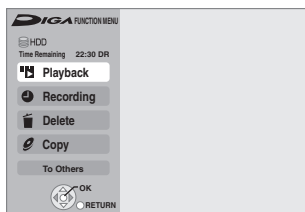

2 Press [▲, ▼] to select an item and press [OK].

• If you select “To Others” and press [OK], the following screen appears. Press [▲, ▼] to select an item and press [OK].



• If you press [RETURN], you can return to the previous screen.

Playback	You can select and play recorded programmes (⇒ 22), change the Play Mode (JPEG, MP3), etc.
Recording	You can easily find programmes you want to watch and set them for timer recording (⇒ 24).
Delete	You can delete items using DELETE Navigator (⇒ 26, 72).
Copy	You can copy recorded titles using COPY Navigator (⇒ 27).
Timer Recording	You can start programming timer recording (⇒ 34).
Advanced Copy	You can make a copy list and then copy (⇒ 52).
Copy New Pictures	You can copy the new still pictures on an SD card (⇒ 64).
Playlists	Playlists recorded on other equipment can be played back. (⇒ 41)
Flexible Rec	The unit sets the best possible picture quality that fits the recording within the remaining disc space (⇒ 32).
DV Auto Rec	DV automatic recording function (⇒ 57)
Recording via AV3 input	You can record to disc from the AV3 input terminals (⇒ 57).
Copy AVCHD	You can copy the HD video (AVCHD format) on a disc or SD card (⇒ 58).
Setup	You can change the unit's settings using Setup menu (⇒ 82).
DVD Management BD Management Card Management	You can manage the discs and cards through formatting, finalising and other operations (⇒ 79).
USB device	This unit displays the menu to help you start USB operations (⇒ 60). • “USB device” appears when a compatible USB device is connected.

To exit the FUNCTION MENU window
Press [FUNCTION MENU].

To pause the TV programme you are watching—Pause Live TV

You can pause the TV programme you are watching using this unit's tuner and resume later by temporarily saving it on the HDD. This is useful when you have to briefly stop watching TV to run an errand. If you stop the Pause Live TV function, then the TV programme temporarily saved on the HDD will be deleted.

Preparation

- Turn on the television and select the appropriate AV input to suit the connections to this unit.
- Turn on this unit.

- 1 Press [INPUT SELECT] to select “TV”.
- 2 Press [▲ ▼ CH] to select the channel.
- 3 When you want to pause the TV programme Press [II].

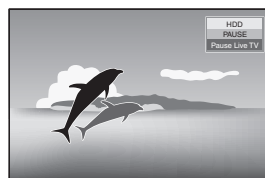

- 4 When you want to resume Press [▶] (PLAY).

- The programme is saved on the HDD in DR recording mode.
- Programmes can be saved temporary up to 8 hours on the HDD. (This may vary depending on the HDD free space.)

Operation during Pause Live TV

Search	Press [◀▶]. The speed increases up to 5 steps. • Press [▶] (PLAY) to restart play.
Pause	Press [II]. • Press [▶] (PLAY) to restart.
Quick View	Press and hold [▶] (PLAY/×1.3). • Press again to return to the normal speed.
Slow-motion	While paused, press [◀◀] or [▶▶]. The speed increases up to 5 steps. • Press [▶] (PLAY) to restart play.
Stop Pause Live TV	1 Press [■]. 2 Press [◀, ▶] to select “Yes” and press [OK].

Note

- Temporary save is stopped in following cases.
 - When save time exceeds 8 hours
 - When there is no HDD free space
 - When 2 programmes are recorded simultaneously
- The Pause Live TV function does not work
 - The clock is not set.
 - While 2 programmes simultaneous recording
 - While watching a programme being recorded
 - When AV1, AV2, AV3, AV4, or DV is selected
- When this unit is not operated for approximately 10 minutes while the screen is being displayed the screen saver is displayed [only when the “Screen Saver” in Setup menu is set to “On” (⇒ 86)]. To return to the previous screen, press [RETURN].

BD-RE BD-R RAM -R -R DL -RW(V) +R +R DL +RW -RW(VR)
SD

Common procedures

Preparation

- Press [DRIVE SELECT] to select the BD or SD drive.

- 1 While stopped
Press [FUNCTION MENU].
- 2 Press [▲, ▼] to select “To Others” and press [OK].



- 3 Press [▲, ▼] to select “BD Management”, “DVD Management” or “Card Management” and press [OK].

e.g., **RAM**

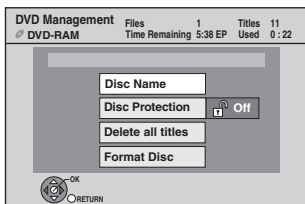

To return to the previous screen

Press [RETURN].

To exit the screen

Press [EXIT].

Note

- **SD** Refer to the Note on page 42 for “Delete BD-Video data” of “Card Management”.

Setting the protection

BD-RE BD-R RAM

Preparation

- Press [DRIVE SELECT] to select the BD drive.

After performing steps 1–3 (⇒ left)

- 1 Press [▲, ▼] to select “Disc Protection” and press [OK].
- 2 Press [◀, ▶] to select “Yes” and press [OK].

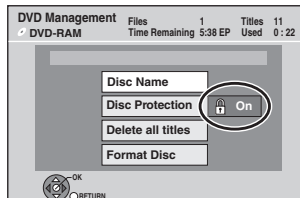

The lock symbol appears closed when the disc is write-protected.

To return to the previous screen

Press [RETURN].

To exit the screen

Press [EXIT].

Providing a name for a disc

BD-RE BD-R RAM -R -R DL -RW(V) +R +R DL +RW

You can provide a name for each disc.

Preparation

- Press [DRIVE SELECT] to select the BD drive.
- **BD-RE BD-R RAM** Release protection (⇒ above, Setting the protection).

After performing steps 1–3 (⇒ left)

- 1 Press [▲, ▼] to select “Disc Name” and press [OK].

(⇒ 73, Entering text)

- The disc name is displayed in the BD/DVD Management window.
- **-R -R DL -RW(V) +R +R DL** With a finalised disc, the name is displayed on the Top Menu.
- **+RW** The disc name is displayed only if you play the disc on other equipment after creating top menu.



To return to the previous screen

Press [RETURN].

To exit the screen

Press [EXIT].

Deleting all titles—Delete all titles

BD-RE BD-R RAM

Preparation

- Press [DRIVE SELECT] to select the BD drive.
- Release protection (⇒ 79, Setting the protection).

After performing steps 1–3 (⇒ 79, Common procedures)

- 1 Press [**▲**, **▼**] to select “Delete all titles” and press [OK].
- 2 Press [**◀**, **▶**] to select “Yes” and press [OK].
- 3 Press [**◀**, **▶**] to select “Start” and press [OK].
A message appears when finished.
- 4 Press [OK].

To return to the previous screen

Press [RETURN].

To exit the screen

Press [EXIT].

Note

- **Once deleted, the recorded contents are lost and cannot be restored.** Make certain before proceeding.
- Still picture data (JPEG) or computer data cannot be deleted.
- Delete does not work if one or more titles are protected.

Enabling the unit's recording function—Format

BD-RE BD-R RAM -RW(V) +RW -RW(VR)

+R +R DL (New disc only)

SD

Preparation

- Press [DRIVE SELECT] to select the BD or SD drive.
- **BD-RE BD-R RAM SD** Release protection (⇒ 11, 79, Setting the protection).

Note

Formatting deletes all contents (including computer data), and they cannot be restored. Check carefully before proceeding. The contents are deleted when you format a disc or card even if you have set protection.

After performing steps 1–3 (⇒ 79, Common procedures)

- 1 Press [**▲**, **▼**] to select, “Format Disc” or “Format Card” and press [OK].
- 2 Press [**◀**, **▶**] to select “Yes” and press [OK].
- 3 Press [**◀**, **▶**] to select “Start” and press [OK].
A message appears when formatting is finished.
- 4 Press [OK].

Note

- When a disc or card has been formatted using this unit, it may not be possible to use it on any other equipment.
- **-R -R DL CD** Formatting cannot be performed.
- You can format DVD-RW only as DVD-Video format on this unit.

To stop formatting **RAM**

Press [RETURN].

- You can cancel formatting if it takes more than 2 minutes. The disc must be reformatted if you do this.

To return to the previous screen

Press [RETURN].

To exit the screen

Press [EXIT].

Selecting the background style—Top Menu

-R -R DL -RW(V) +R +R DL +RW

You can select the background that will be displayed as the DVD-Video top menu after finalising or Create Top Menu (**+RW**).

Preparation

Press [DRIVE SELECT] to select the BD drive.

After performing steps 1–3 (⇒ 79, Common procedures)

- 1 Press [**▲**, **▼**] to select “Top Menu” and press [OK].
- 2 Press [**▲**, **▼**, **◀**, **▶**] to select the background and press [OK].

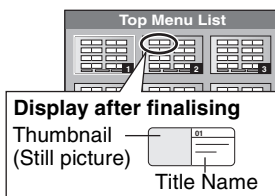

- You can change thumbnails displayed in the top menu. (⇒ 45, Change Thumbnail)

Selecting whether to show the Top Menu first—Auto-Play Select

-R -R DL -RW(V) +R +R DL +RW

You can select whether to show the top menu after finalising.

Preparation

Press [DRIVE SELECT] to select the BD drive.

After performing steps 1–3 (⇒ 79, Common procedures)

- 1 Press [**▲**, **▼**] to select “Auto-Play Select” and press [OK].
- 2 Press [**▲**, **▼**] to select “Top Menu” or “Title 1” and press [OK].

Top Menu: The top menu appears first.
Title 1: The disc content is played without displaying the top menu.

Enabling discs to be played on other equipment—Finalise

BD-R -R -R DL -RW(V) +R +R DL

Make selections from “Top Menu” and “Auto-Play Select” (⇒ above) before finalising the disc.

Preparation

Press [DRIVE SELECT] to select the BD drive.

After performing steps 1–3 (⇒ 79, Common procedures)

- 1 Press [**▲**, **▼**] to select “Finalise” and press [OK].
- 2 Press [**◀**, **▶**] to select “Yes” and press [OK].
- 3 Press [**◀**, **▶**] to select “Start” and press [OK].

A message appears when finalising is finished.

Note

- You cannot cancel finalising.
- Finalising takes up to 15 minutes.
(**-R DL +R DL** Finalising takes up to 60 minutes.)
- Do not disconnect the AC mains lead while finalising. This will render the disc unusable.

- 4 Press [OK].

Note

When finalising a high-speed recording compatible disc, it may take longer than displayed on the confirmation screen (approximately four times).

After finalising

- **BD-R -R -R DL +R +R DL** The disc becomes play-only and you can no longer record or edit.
- **-RW(V)** You can record and edit the disc after formatting (⇒ 80) although it becomes play-only after finalising.

	Before finalising	After finalising
Recording/Editing/Entering name	○	—
Play on other players	—	○

- You cannot finalise discs recorded on other manufacturer's equipment.
- If you finalise discs recorded on Panasonic equipment other than this unit, the background selected as “Top Menu” may not be displayed.
- Discs finalised on this unit may not be playable on other players due to the condition of the recording.

Creating Top Menu—Create Top Menu

+RW

+RW discs contain no Top Menu data. Top Menu is a convenient function. We recommend you create the menu before playing a +RW disc on other equipment.

You cannot use the Top Menu for playing on this unit.

Make selections from “Top Menu” and “Auto-Play Select” (⇒ left) before creating top menu.

Preparation

Press [DRIVE SELECT] to select the BD drive.

After performing steps 1–3 (⇒ 79, Common procedures)

- 1 Press [**▲**, **▼**] to select “Create Top Menu” and press [OK].
- 2 Press [**◀**, **▶**] to select “Yes” and press [OK].
- 3 Press [**◀**, **▶**] to select “Start” and press [OK].
Creating Top Menu starts. You cannot cancel creating. Creating Top Menu can take a few minutes.
- 4 Press [OK].

Note

- You can record or edit discs after creating the Top Menu. But the created menu is deleted when you record or edit disc. In such cases, create the Top Menu again by using “Create Top Menu”.

To return to the previous screen

Press [RETURN].

To exit the screen

Press [EXIT].

Changing the unit's settings

You can change the unit's settings using Setup menu.
• The settings remain intact even if you switch the unit to standby.

Common procedures

- 1 While stopped
Press [FUNCTION MENU].
- 2 Press [▲, ▼] to select "To Others" and press [OK].
- 3 Press [▲, ▼] to select "Setup" and press [OK].

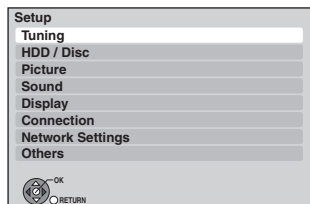

- 4 Press [▲, ▼] to select the tab and press [OK].
- 5 Press [▲, ▼] to select the menu and press [OK].
- 6 Press [▲, ▼, ◀, ▶] to select the option and press [OK].
• Follow the instruction on the screen if the operation method is different.

To return to the previous screen
Press [RETURN].

To exit the screen
Press [EXIT].

Tuning

■ Edit Favourites

You can create four groups of channels for making viewing and recording easier. Editing these groups does not affect the channel setting itself.

- Timer recording may not work correctly if you edit the groups during timer recording standby.

Press the "Blue" button to select the group.

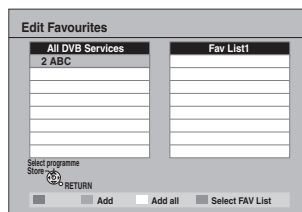

To add channels to a group

- ① Press [▲, ▼] to select the channel in the "All DVB Services" column and press the "Green" button.
 - Repeat this step to add other channels.
 - Press the "Yellow" button to add all the available channels to the group. (This function is available only when no channels have been added to the group.)
- ② Press [OK] to save the group.

To change the order of channels of a group

- ① Press [▶]*.
- ② Press [▲, ▼] to select the channel in the "Fav List" column to move and press the "Green" button.
- ③ Press [▲, ▼] to select the new position of the channel and press the "Green" button.
 - Repeat the steps ② – ③ to move other channels.
- ④ Press [OK] to save the group.

To delete channels on a group

- ① Press [▶]*.
- ② Press [▲, ▼] to select the channel in the "Fav List" column and press the "Yellow" button.
 - Repeat this step to delete other channels.
 - Press the "Blue" button to delete all the channels from the group.
- ③ Press [OK] to save the group.
Deleting a channel from a group does not affect the channel itself. You can still select the channel from the "All DVB Services" group.

To change the name of a group in the "Fav List" column

- ① Press [▶]*.
- ② Press the "Red" button.
 - User input screen appear.
- ③ Press [▲, ▼, ◀, ▶] to select a character and press [OK].
Repeat this step to enter other characters.
 - **To delete a character**
Press the "Blue" button.
- ④ Press the "Red" button.

* When the station name of the "All DVB Services" column is highlighted

■ Auto-Setup

Download from TV

You can restart auto channel setting if set up (⇒ 18) fails for some reason.

Select "Download from TV" when you connect the unit to a VIERA Link (HDMI Control 3) compatible TV with an HDMI cable.

When the confirmation screen appears

Press [◀, ▶] to select "Yes" and press [OK].

You can also use the following method to restart Auto-Setup.

When the unit is on and stopped

Press and hold [▼ CH] and [CH ▲] on the main unit until Region Selection screen appears. (⇒ 18)

All the settings except for the ratings level, ratings password and clock settings return to the factory preset. The timer recording programmes are also cancelled.

■ DVB Manual Tuning

You can set channels manually that the DVB Auto-Setup could not complete successfully.

- 1 Press [▲, ▼] to select "DVB Manual Tuning" and press [OK].

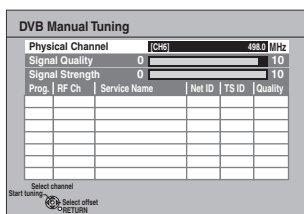

- 2 Press [▲, ▼] to select the channel you want to set.
- 3 Press [◀, ▶] to adjust the frequency.
 - The frequency rises and falls in steps of 0.125 MHz.
 - Adjust the frequency by checking the signal strength and signal quality displays. [Refer to "DVB Signal Display" (⇒ below) for signal quality and signal strength.]
- 4 Press [OK] to start scan. The set channel is displayed in the table.
- 5 Press [EXIT] and press [^ v CH] to check that applicable channels have been selected.

■ Add New Service

You can search for newly added terrestrial digital channels to receive.

- 1 Press [▲, ▼] to select "Add New Service" and press [OK]. The unit starts searching for newly available terrestrial digital channels. This takes about 3 minutes.

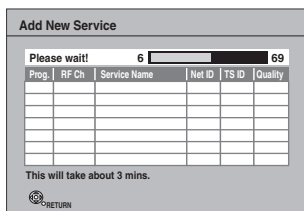

A message is displayed when the search is finished. "No services found" is displayed when no new services can be found.

- 2 Press [OK] to save the newly found channels.

■ DVB Signal Display

You can check the quality and strength of digital broadcast signals. Realign the aerial if you are receiving a poor signal.

When "DVB Signal Display" is displayed in grey and cannot be selected:

- 1 Press [EXIT] to exit the screen.
- 2 Press [INPUT SELECT] to select "TV".
- 3 Display the Setup menu again (⇒ 82).

Press [▲, ▼] to select "DVB Signal Display" and press [OK]. The quality and strength of the signal are shown. Press [^ v CH] to select the channel.

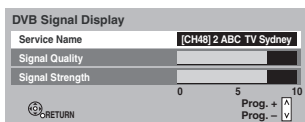

Signal Quality

Below 2 (display red):

The signal quality is so poor that there may be interference in the pictures and sound.

2–5 (display orange):

The signal quality is basically adequate, but brief interference in the pictures and sound is possible in isolated case.

Over 5 (display green):

Optimum picture and sound quality.

Signal Strength

The display for signal strength is grey. "0" means signal strength 0%, "10" means signal strength 100%.

If the signal is too strong, the display will change from grey to red. Reduce the signal amplification at your aerial.

• When the signal is weak:

- adjust the position and direction of the aerial.
- adjust the aerial reception with "DVB Manual Tuning" in the Setup menu (⇒ above).
- check that the current digital broadcast channel is correctly broadcasting.

■ New Service Message

When a new DVB channel is added, this unit will be informed automatically. Then the confirmation message appears. If you press [OK], Auto-Setup starts (all channel settings and all created categories are deleted. The timer recording programmes are also cancelled.).

- 1 Press [▲, ▼] to select "New Service Message".
- 2 Press [◀, ▶] to select "Automatic" or "Off".

[Automatic]

[Off]

The service messages are not shown.

HDD/Disc

(All factory default settings are indicated with underlined text.)

Settings for Playback

• Press [OK] to show the following settings.

Soundtrack for BD-Video/DVD-Video

[English] [German] [French] [Italian]
 [Spanish]
 [Original] The original language of each disc will be selected.
 [Other ****]*

Subtitle for BD-Video/DVD-Video

[Automatic] If the language selected for "Soundtrack" is not available, subtitles of that language will automatically appear if available on that disc.
 [English] [German] [French] [Italian]
 [Spanish]
 [Other ****]*

Menu for BD-Video/DVD-Video

[English] [German] [French] [Italian]
 [Spanish]
 [Other ****]*

Play AVCHD on BD-RE/BD-R

Set when you are playing a disc that has high definition video (AVCHD) recorded by the camcorder and high definition quality title that was recorded on this unit.

• It can be played regardless of the setting for discs that do not have both recorded.

[On] Playback high definition video (AVCHD)
 [Off] Playback high definition quality title

BD-Video Ratings

Set a ratings level to limit BD-Video play. Follow the on-screen instructions. Enter a 4-digit password with the numbered buttons when the password screen is shown. It will be the common password for both "DVD-Video Ratings" and "BD-Video Ratings".

Do not forget your password.

Setting ratings (When no limit is selected)

[No Limit] All BD-Video can be played.
 [0 to 254 year(s)] Prohibits play of BD-Video with corresponding ratings recorded on them.

• Changing settings [When 0 to 254 year(s) is selected]

[Unlock Recorder] [Change Password]
 [Change Level] [Temporary Unlock]

DVD-Video Ratings

Set a ratings level to limit DVD-Video play. Follow the on-screen instructions. Enter a 4-digit password with the numbered buttons when the password screen is shown. It will be the common password for both "DVD-Video Ratings" and "BD-Video Ratings".

Do not forget your password.

Setting ratings (When level 8 is selected)

[8 No Limit] All DVD-Video can be played.
 [1 to 7] Prohibits play of DVD-Video with corresponding ratings recorded on them.

[0 Lock All] Prohibits play of all DVD-Video.

• Changing settings (When level 0 to 7 is selected)

[Unlock Recorder] [Change Password]
 [Change Level] [Temporary Unlock]

* [Other ****]

Enter a code (⇒ 101) with the numbered buttons. When the selected language is not available on the disc, the default language is played. There are discs where you can only switch the language from the menu screen (⇒ 22).

BD-V DVD-V

Choose the language for audio, subtitle and disc menus.

• Some discs start in a certain language despite any changes you make here.

Settings for Recording

• Press [OK] to show the following settings.

Recording time in EP mode

Select the maximum number of hours for recording in EP mode (⇒ 30, Recording modes and approximate recording times).

[6 hours] You can record for 6 hours on an unused 4.7 GB disc.
 [8 hours] You can record for 8 hours on an unused 4.7 GB disc.

• The sound quality is better when using "6 hours" than when using "8 hours".

Aspect for Recording

Sets the aspect ratio when recording.

It is valid when recording in following.

• When recording to DVD-R, DVD-R DL or DVD-RW (DVD-Video format)

• When the "Rec for High Speed Copy" is enabled (⇒ below)

[Automatic] The programme will be recorded in the original aspect used when recording started (including when recording started at a commercial, etc.).

[16:9] [4:3]

• When recording to the HDD, BD-RE, BD-R or DVD-RAM with "Rec for High Speed Copy" set to "Off", programme will be recorded in the original aspect ratio.

• In the following cases, even when set to "Automatic" or "16:9", recordings will be made or copied in 4:3.

- **[R -R DL -RW(V)]** When the recording mode is set to "EP" or "FR (recordings 5 hours or longer)" mode.
- When recording to a +R, +R DL and +RW.

Rec for High Speed Copy

You can copy recorded titles from the HDD to DVD-R, DVD-R DL, DVD-RW (DVD-Video format), +R, +R DL and +RW using high speed mode. However, screen size, etc. is restricted (⇒ below).

We recommend turning the setting "Off" if high speed copy to DVD-R, etc. is not necessary when recording a programme.

This setting is valid for the following cases:

- Recording TV programmes in XP, SP, LP, EP, or FR modes
- Recording from an external equipment (including DV equipment)
- Copying from a finalised DVD-Video disc.

[On] You can high-speed copy to DVD-R, etc. Press [◀, ▶] to select "Yes" and press [OK].

• The following restrictions are applied to recorded titles.

- Recordings are made using the aspect ratio set in "Aspect for Recording" (⇒ above).
- Select the type of audio in advance from "Bilingual Audio Selection" (⇒ 85).
- You are no longer able to switch the audio when watching a programme on an input channel on the TV connected to this unit.

[Off]

BD/DVD Speed for High Speed Copy

Select the speed of high-speed copying (When using high-speed copy compatible discs).

[Maximum]

[Normal (Silent)] The noise generated by this unit is less than when "Maximum" is selected, however the time required for copying will double (approximately).

HDD Management

• Press and hold [OK] to show the following settings.

Delete all titles

Delete all titles.

• Delete does not work if one or more titles are protected.

Format HDD

Format of the HDD is performed.

Picture

(All factory default settings are indicated with underlined text.)

Still Mode

Select the type of picture shown when you pause play (⇒ 114, Frames and fields).

[Automatic]

[Field] Select if jittering occurs when "Automatic" is selected. (The picture is coarser.)

[Frame] Select if small text or fine patterns cannot be seen clearly when "Automatic" is selected. (The picture is clearer and finer.)

Seamless Play

Select the play mode between playlist chapter segments and partially deleted titles.

● It is not valid for titles in DR mode or AVCHD videos.

[On] The chapters in playlists are played seamlessly. This does not work when there are several audio types included on the playlist and when using Quick View (PLAY×1.3). Additionally, the positioning of chapter segments may change slightly.

[Off] The points where chapters in playlists change are played accurately, but the picture may freeze for a moment.

NTSC Video Output

Select how the NTSC image is output.

[NTSC] Output as NTSC.

[PAL60] Convert and output as PAL60.
Select this when connected to the PAL format TV.

Sound

(All factory default settings are indicated with underlined text.)

Dynamic Range Compression

[BD-V] [DVD-V]

Change the dynamic range for late night viewing.

[On] [Off]

Bilingual Audio Selection

(Only when recording from DV input)

Select whether to record the main or secondary audio type when:

● Copying to a DVD-R, DVD-RW (DVD-Video format), +R and +RW.

● "Rec for High Speed Copy" is enabled. (⇒ 84)

● Recording sound in LPCM (⇒ 86, "Audio Mode for XP Recording").

[M 1] [M 2]

● You cannot select the audio on this unit when recording from an external source, such as when copying from a video cassette recorder (except from DV equipment connected to this unit's DV input terminal). Select the audio on the other equipment.

● When recording from the unit's DV terminal, select the type of audio recording from "Audio Mode for DV Input" (⇒ 86).

Digital Audio Output

● Press [OK] to show the following settings.

PCM Down Conversion

Select how to output audio with a sampling frequency of 96 kHz. It will be converted to 48 kHz regardless of the setting in following cases.

● The signals have a sampling frequency of over 96 kHz.

● The disc has copy protection.

● "BD-Video Secondary Audio" is set to "On". ([BD-V])

[On] Signals are converted to 48 kHz. (Choose when the connected equipment cannot process signals with a sampling frequency of 96 kHz.)

[Off] Signals are output as 96 kHz. (Choose when the connected equipment can process signals with a sampling frequency of 96 kHz.)

Priority Setting

Select priority items for "Dolby D/Dolby D +/Dolby TrueHD", "DTS/DTS-HD", "MPEG" and "BD-Video Secondary Audio".

● See "Enjoying High Bit rate Audio and Video of BD-Video" (⇒ 43)

[Secondary Audio] "BD-Video Secondary Audio" is set to "On", and "Dolby D/Dolby D +/Dolby TrueHD", "DTS/DTS-HD", "MPEG" are fixed to "PCM".

[Audio Quality] "Dolby D/Dolby D +/Dolby TrueHD", "DTS/DTS-HD", "MPEG" are set to "Bitstream", and "BD-Video Secondary Audio" is fixed to "Off".
– If the connected equipment can only decode Dolby Digital and DTS, Dolby Digital Plus, Dolby TrueHD, and DTS-HD will be output as Dolby Digital or DTS.
– If the connected equipment can only decode one of either Dolby Digital and DTS, please select "User Setting" and set desired audio formats that cannot be decoded.

[User Setting] Items in "Dolby D/Dolby D +/Dolby TrueHD", "DTS/DTS-HD", "MPEG" and "BD-Video Secondary Audio" can be set individually.

Dolby D/Dolby D +/Dolby TrueHD DTS/DTS-HD MPEG

Select to output Dolby Digital, Dolby Digital plus, Dolby TrueHD, DTS Digital surround, DTS-HD High Resolution Audio, DTS HD Master Audio, or MPEG as bitstream or PCM.

Note

● Not making the proper settings may result in noise.

● If the unit is connected with the HDMI AV OUT terminal, the specifications of the connected equipment take preference over this unit and audio selected in these items may not be output (e.g., when a television is connected, the HDMI audio output of this unit is limited to down-mixed 2ch.)

[Bitstream] Select "Bitstream" when the connected equipment can decode the respective audio format.
– Connect equipment supporting HDMI Ver. 1.3 and use a High Speed HDMI Cable in order to output high bit rate audio such as Dolby Digital Plus, Dolby TrueHD, DTS-HD High Resolution Audio or DTS-HD Master Audio.

[PCM] Select "PCM" when the connected equipment cannot decode the respective audio format.

Refer to the operating instructions for connected devices to verify whether or not they can decode each of the audio formats.

BD-Video Secondary Audio

([BD-V] with secondary audio)

Turn on/off the clicking sound on the menu and audio with secondary video.

[On] The sampling frequency is converted to 48 kHz. Audio will be converted to Dolby digital during playback of the BD-Video with secondary audio when "Bitstream" (⇒ above) is selected.

[Off] Output in original audio method.

Audio Mode for XP Recording

Choose the audio type when recording or copying with XP mode.

[Dolby Digital] (⇒ 114) [LPCM] (⇒ 114)

- The picture quality of LPCM recordings may be lower than that of normal XP mode recordings.
- The audio recording becomes Dolby Digital even if you selected LPCM when using a recording mode other than XP.
- When recording a bilingual broadcast, select the type of audio in advance from "Bilingual Audio Selection" (⇒ 85).

Audio Mode for DV Input

You can select the kind of audio when recording from the unit's DV input terminal (⇒ 56).

[Stereo 1] Records audio (L1, R1).

[Stereo 2] Records added audio such as narration (L2, R2) subsequent to original recording.

[Mix] Records both Stereo 1 and Stereo 2.

- When recording bilingual broadcast, select the type of audio in advance from "Bilingual Audio Selection" (⇒ 85).

Audio Mode for Digital Broadcast

Selects the initial setting for Audio tracks, If programme has both Dolby Digital and MPEG audio tracks, priority is given to what you select.

Only the selected audio is recorded when recorded or copied in XP, SP, LP, EP, or FR recording mode.

(It is recorded in accordance with the setting of the "Multi Audio" in Disc menu only when it is copied with "Copy Title Playing".)

[Dolby Digital] A method of coding digital signals developed by Dolby Laboratories. Apart from stereo (2ch) audio, these signals can also be multi-channel audio.

[MPEG] An audio compression method that compresses audio to small size without any considerable loss of audio quality.

Display

(All factory default settings are indicated with underlined text.)

On-Screen Messages

Choose the approximate time until the digital channel information screen (⇒ 21) disappears automatically.

The length of time the control panel (⇒ 75) is displayed can also be changed, but "Off" does not work.

[Off] (The digital channel information is not displayed.)

[3 sec.] [5 sec.] [7 sec.] [10 sec.]

FL Display

Changes the brightness of the unit's display.

This setting is fixed with "Automatic" if you set "Power Save" (⇒ 89) to "On".

[Bright] [Dim]

[Automatic] The display turns dark during play and disappears when the unit is turned off. It reappears momentarily if a button is pressed. While using this mode, the standby power consumption can be reduced.

Screen Saver

This is to prevent burn-in on the screen.

- When this is set to "On", the masked-off area on the screen becomes grey.

[Only when connecting with an HDMI cable or a component video cable and "HDMI Video Format" (⇒ 87) is set to any other mode than "576p/480p", or "Component Resolution" (⇒ 87) is set to "720p" or "1080i"]

[On] If there is no operation for 10 minutes or more, the displayed screen switches to the other states automatically.

- When the Direct Navigator, TV Guide, Timer recording list, COPY Navigator, DELETE Navigator or FUNCTIONS menu is displayed, the display on the screen is not displayed.
- When Music is played, the display returns to the screen saver mode. (Playback continues.)
- When still pictures are shown (except for slideshows), the display returns to the Direct Navigator screen.
- The display returns to the screen saver mode when it is paused by the Pause Live TV. (Pause status will continue.)

[Off]

Teletext

Select the Teletext display mode. (⇒ 21)

[TOP]

[List]

SD Card LED Control

Set the lighting method for the lamp on the SD card slot.

[On]

[Off]

[SD inserted] When this unit is turned on and SD card is inserted, the lamp is lighted.

Connection

(All factory default settings are indicated with underlined text.) Depending on the connected equipment, some items may be shaded in grey on the display and cannot be selected, or you may not be able to change the settings.

TV Aspect

Set to match the type of television connected.

[16:9] When connected to a 16:9 widescreen television.

[Pan & Scan] When connected to a 4:3 aspect television, side picture is trimmed for 16:9 picture.



[Letterbox] When connected to a 4:3 aspect television. 16:9 picture is shown in the letterbox style.



Aspect for 4:3 Video

To play a 4:3 title, set how to show pictures on a 16:9 widescreen television.

[4:3] Picture output expands left or right.



[16:9] Picture is output as original aspect with side panels.



TV System

Change the setting to match the equipment you are connecting with, or to match the title when there are both PAL and NTSC titles on the HDD, BD-RE or BD-R.

[PAL] ● Select when connecting to a PAL or Multi-system television.
● Select to record television programmes and PAL input from other equipment.
● Select when playing a PAL input title recorded on the HDD, BD-RE or BD-R.

[NTSC] ● Select when connecting to a NTSC television. Television programmes cannot be recorded properly.
● Select to record NTSC input from other equipment.
● Select when playing a NTSC input title recorded on the HDD, BD-RE or BD-R.

Note

- This unit cannot record NTSC signals to discs that already have PAL signal recordings. (However, both types of programmes can be recorded onto the HDD, BD-RE or BD-R.)
- If "NTSC" has been selected, the TV Guide system cannot be used.
- A disc or title with different "TV System" may not be able to playback while recording or on standby for the timer recording. You will be able to playback by changing the "TV System" settings in that case, but to prevent failure of the timer recording, change back the settings before the recording starts.

To change the setting all at once (PAL ↔ NTSC)

While stopped, keep pressing [■] and [▲ OPEN/CLOSE] on the main unit at the same time for 5 or more seconds.

■ Types of disc or title recorded on HDD, BD-RE or BD-R for the type of connected TV

When you use the discs recorded either PAL or NTSC, or playback a title recorded on HDD, BD-RE or BD-R using PAL or NTSC, refer to this table.

(○: Possible to view, –: Impossible to view)

TV type	Disc/Titles recorded on HDD, BD-RE or BD-R	Yes/No
Multi-system TV	PAL	○
	NTSC	○
PAL TV	PAL	○
	NTSC	○*1 (PAL60)
NTSC TV	PAL	–
	NTSC	○*2

*1 Select "PAL60" for "NTSC Video Output" in the Setup menu (➔ 85). If your television is not equipped to handle PAL 525/60 signals the picture will not be shown correctly.

*2 Select "NTSC" in "TV System".

- When playing back a title recorded on the HDD, BD-RE or BD-R, ensure that you match the "TV System" setting to the title (PAL or NTSC).

HDMI Connection

- Press [OK] to show the following settings.

HDMI Video Mode

Select "On" when video is output from HDMI AV OUT terminal.

[On]

[Off] When the equipment such as amplifiers is connected using HDMI cable, and TV is connected to the COMPONENT VIDEO OUT terminal (setup before connecting to the amplifiers.)

HDMI Video Format

You can only select items compatible with the connected equipment. This setting normally does not need to be changed. However if you are concerned about output picture quality, it may be improved by changing the setting.

- To enjoy High Quality Video up-converted to 1080p, you need to connect the unit directly to 1080p compatible HDTV. If this unit is connected to an HDTV through other equipment, it must also be 1080p compatible.

[576p/480p]

[720p] All images other than 720p will be output as 1080i.

[1080i]

[1080p] When outputting 1080p signal, we recommend using High Speed HDMI Cables that have the HDMI logo (as shown on the cover) and are less than 5.0 meters to prevent video distortion etc.

[Automatic] Automatically selects the output resolution best suited to the connected television (1080p, 1080i, 720p or 576p/480p).

- Press the [■] and [▶] (PLAY) for more than 5 seconds when the image is disturbed by changing the setting. It will be set to "576p/480p".

BD-Video 24p Output

When playing BD-Video and DVD-Video recorded in 24 frames, this unit displays each frame at 1/24 second intervals—the same interval originally shot with the film movie.

- This item is effective only when the unit is connected to a TV with an HDMI terminal that supports 1080/24p input.

[On]

- Images in 24p are output in 24p as they are. (Only when the "HDMI Video Format" is "Automatic" or "1080p")

However,

- when video is being output at 24 frames, images from any other terminal than the HDMI terminal may not be output properly.
- when images other than 24p are played, images are output at 60p.

[Off]

HDMI Audio Output

[On]

[Off] When connected to TV with HDMI cable, and connected to amplifiers not compatible to HDMI with a DIGITAL AUDIO OUT terminal

VIERA Link

Set to use "HDAVI Control" function when connected with an HDMI cable to a device that supports "HDAVI Control".

[On]

[Off] Select when you do not want to use "HDAVI Control".

Component Resolution

This sets the video output resolution when using the component video terminal.

[576i/480i] [576p/480p] [720p] [1080i]

- If it is set to "720p", images other than "720p" will be output as "1080i".
- Press the [■] and [▶] (PLAY) for more than 5 seconds when the image is disturbed by changing the setting. It will be set to "576i/480i".

Speaker

You can set the unit to output the best possible sound for your speakers. (Only when connected to amplifier with HDMI AV OUT terminal)

[Multi-Channel] When using 3 or more speakers.

[2-Channel] When using two speakers

■ When "Multi-Channel" is selected

- It is only valid when the settings in "Digital Audio Output" are set to "PCM". (→ 85)
- If the delay cannot be set in the connected amplifier, set as following depending on the connected speakers.

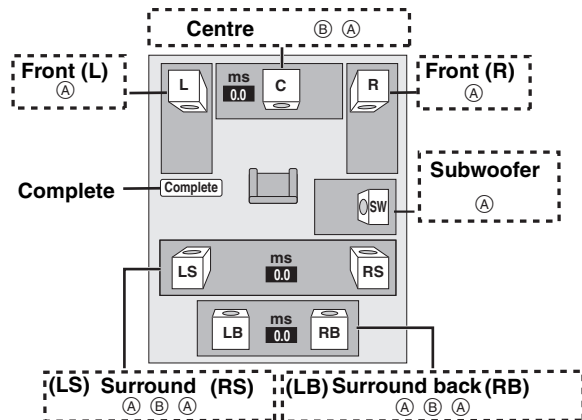

Speaker presence and size (A)

- 1 Press [▲, ▼, ◀, ▶] to select the speaker icon (A) and press [OK].
- 2 Press [▲, ▼] to select the setting and press [OK].

Icon examples:

- Surround speaker (LS)
- **Large:** Select when the speaker supports low-frequency (under 100 Hz) reproduction.
 - **Small:** Select when the speaker does not support low-frequency reproduction.

In order to make an ideal listening environment, settings of speaker sizes may be automatically adjusted. For example, if the subwoofer is set to "No", the front speakers will automatically be set to "Large". (In this case, we recommend connecting a speaker that can reproduce bass below 100 Hz.)

Delay time (B)

For optimum listening with 7.1/5.1-channel sound, all the speakers, except for the subwoofer, should be the same distance from the seating position. If you have to place the centre, surround and surround back speakers closer to the seating position, adjust the delay time to make up for the difference. If either distance (D) or (F) is less than (E), find the difference in the relevant table and change to the recommended setting.

- 1 Press [▲, ▼, ◀, ▶] to select the delay time box (B) and press [OK].
- 2 Press [▲, ▼] to select the setting and press [OK].

5.1ch speaker connection

7.1ch speaker connection

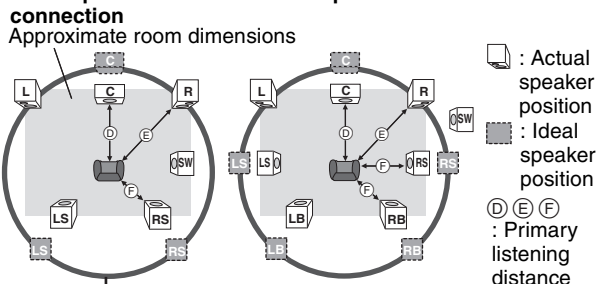

Circle of constant primary listening distance

D Centre speaker

Difference	Setting
Approx. 34 cm	1.0 ms
Approx. 68 cm	2.0 ms
Approx. 102 cm	3.0 ms
Approx. 136 cm	4.0 ms
Approx. 170 cm	5.0 ms

F Surround/Surround back speakers

Difference	Setting
Approx. 170 cm	5.0 ms
Approx. 340 cm	10.0 m
Approx. 510 cm	15.0 m

AV1 Output

Set according to the terminal of the connected TV. Select "Video" or "S Video" for component output (progressive output). If this unit is connected with an HDMI cable, you cannot select "RGB 1" or "RGB 2".

[Video]

Select when a TV is connected that can receive a composite signal.

[S Video]

Select when a TV is connected that can receive an S Video signal.

[RGB 1]

Select when a TV is connected that can receive an RGB signal. If you always would like to view the picture from the unit in RGB signal, select this mode. The TV screen will automatically switch to display the picture from the unit when the unit is turned on.

[RGB 2]

Select when a TV is connected that can receive an RGB signal. If you would like to switch to display the picture from the unit only when playback or viewing menus, select this mode.

AV2 Input

Set according to the output signal of the connected equipment.

[Video]

[S Video]

Network Settings

IP Address/DNS Settings (→ 90)

- Press [OK] to show the following settings.

Connection Test

[--]

IP Address Auto-assignment

[On] [Off]

IP Address

[---.---.---.---]

Subnet Mask

[---.---.---.---]

Gateway Address

[---.---.---.---]

DNS-IP Auto-assignment

[On] [Off]

Primary DNS

[---.---.---.---]

Secondary DNS

[---.---.---.---]

Connection Speed Auto-configure

[On] [Off]

Connection Speed Setting

This is enabled only when "Connection Speed Auto-configure" is turned "Off".

[10BASE half duplex] [10BASE full duplex]
[100BASE half duplex] [100BASE full duplex]

Proxy Server Settings (→ 91)

- Press [OK] to show the following settings.

Initialize

Set the setting of the "Proxy Server Settings" back.

Proxy Address

(The initial setting blank.)

Proxy Port Number

(The initial setting is "0".)

Others

(All factory default settings are indicated with underlined text.)

Off Timer

Select how long the unit remains on when it is not being used.

[2 hours] [4 hours] [6 hours] [Off]

Remote Control

Change the remote control code on the main unit and the remote control (the two must match) if you place other Panasonic products close together.

[BD 1] [BD 2] [BD 3]

Use "BD 1", the factory set code, under normal circumstances.

- 1 Press [**▲**, **▼**] to select the code ("BD 1", "BD 2" or "BD 3") and press [OK].

To change the code on the remote control

- 2 While pressing [OK], press and hold the numbered button ([1], [2] or [3]) for more than 5 seconds.
- 3 Press [OK].

■ When the following indicator appears on the unit's display



The unit's remote control code

Change the code on the remote control to match the main unit's (⇒ step 2).

Note

Executing "Shipping Condition" in the Setup menu returns the main unit code to "BD 1". Change the remote control code to 1 (⇒ step 2).

Clock

- Press [OK] to show the following setting.

Auto Clock Setting

This unit usually obtains time and date information from digital broadcasts. But, if the time is not set correctly, set it to "Off" and perform the "Manual Setting". (⇒ below)

[On] [Off]

Region Selection

Select the region where you live to adjust the standard time.

- The time contained in the broadcast signal is UTC (Universal time, coordinated).

[NSW/ACT] [Victoria] [Queensland]
 [South Australia] [Western Australia]
 [Northern Territory] [Tasmania]

Daylight Saving Time

Select time offset from the standard time for Summer Time.

- Normally select "Auto".
- If there is a gap between displayed time and actual time, set this function.

[Auto] [0 hour] [+1/2 hour] [+1 hour]

Manual Setting

- Press [OK] to show the following setting.

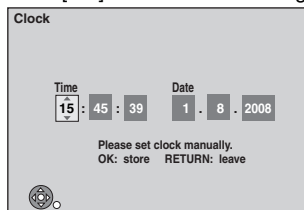

- 1 Press [**◀**, **▶**] to select the item you want to change. The items change as follows:
 Hour ↔ Minute ↔ Second ↔ Day ↔ Month ↔ Year
- 2 Press [**▲**, **▼**] to change the setting.
- 3 Press [OK] when you have finished the settings. The clock starts.

Power Save

[On] Power consumption is minimized when the unit is turned to standby (⇒ 113).

[Off]

(If "Quick Start" is set to "On", "Power Save" is automatically turned to "Off".)

- Refer to the following when "Power Save" is set to "On".
 - "FL Display" is automatically set to "Automatic" (⇒ 86).
 - The "Quick Start" function does not work. (It is automatically turned to "Off".)

Quick Start

Speed of startup from power off is increased.

(When connecting to TV using 21-pin Scart, COMPONENT VIDEO, VIDEO or S VIDEO terminals)

[On]

[Off] Standby power consumption is less than when this is set to "On".

(If this is set to "On", "Power Save" is automatically turned to "Off".)

- Startup takes up to a minute when:
 - A disc other than DVD-RAM is inserted.
 - You want to make other operations.
 - The clock has not been set.
- Depending on the type of TV or the connected terminal, it may take time to display the screen.

System Update (⇒ 93)

In order to update this unit's software and to support system changes made by broadcasts, this unit periodically performs software updates.

Press [OK] to show the following settings.

Software Update in Standby

[On] When you set this unit to standby mode, software updates are downloaded automatically.

[Off]

Software Licence

Information about the software licence is displayed.

Initialize

- Press [OK] to show the following settings.

Shipping Condition

All the settings except for the ratings level and ratings password return to the factory preset. The timer recording programmes are also cancelled.

[Yes] [No]

Default Settings

All the settings other than the tuning settings, clock settings, disc language settings, ratings level, ratings password, remote control code, network settings return to the factory presets.

[Yes] [No]

Network Settings

These settings are used if you will connect this unit to a network. The connection to the Internet may take time or the internet may not be connected depending on the connection environment. It is recommended that you use a broadband connection.

Preparation

Connect to the network. (⇒ 98)

■ Testing the connection

Always test the connection when a LAN cable is connected or when new "IP Address/DNS Settings" have been made.

- 1 Press [FUNCTION MENU].
- 2 Press [▲, ▼] to select "To Others" and press [OK].
- 3 Press [▲, ▼] to select "Setup" and press [OK].
- 4 Press [▲, ▼] to select "Network Settings" and press [OK].
- 5 Press [▲, ▼] to select "IP Address/DNS Settings" and press [OK].
- 6 Press [▲, ▼] to select "Connection Test" and press [OK].

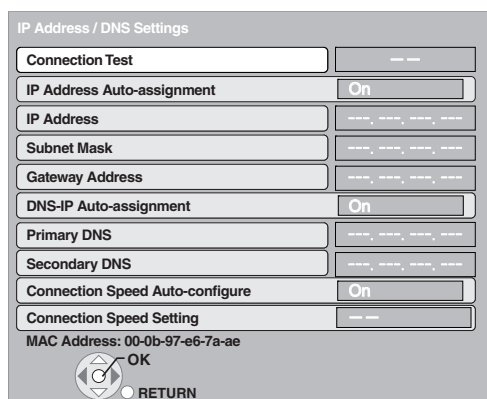

- "Testing": The test is in progress.
- "OK": The connection is completed.
- "Failed": Please check the connection and settings.

■ Setting the IP address

In most cases, default settings can normally be used without making any changes.

Set the IP address only when the router has no DHCP server functions or when the router's DHCP server function is disabled.

After performing steps 1–5 (⇒ above)

- 6 Press [▲, ▼] to select "IP Address Auto-assignment" and press [◀, ▶] to select "Off".
- 7 Press [▲, ▼] to select "IP Address", "Subnet Mask" or "Gateway Address" and press [OK].
- 8 Enter numbers with the numbered buttons and press [OK].
 - After checking the specifications for your broadband router, enter each number.
 - If the number is unknown, then check the number of other devices such as personal computers connected via a LAN cable. Assign a different number from those of other devices for the "IP Address" and the same number for others.
 - If a wrong number is entered, then press [DELETE *].

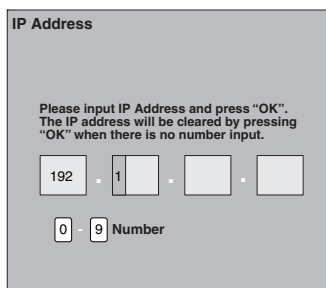

- 9 Press [◀, ▶] to select "Yes" and press [OK].

Note

- The numeric input range is between 0 and 255.

■ Setting the DNS-IP

In most cases, default settings can normally be used without making any changes.

When setting an assigned DNS server from your internet service provider, perform the following settings.

After performing steps 1–5 (⇒ left)

- 6 Press [▲, ▼] to select "IP Address Auto-assignment" and press [◀, ▶] to select "Off".
- 7 Press [▲, ▼] to select "Primary DNS" or "Secondary DNS" and press [OK].
- 8 Enter numbers with the numbered buttons and press [OK].
 - Follow the instructions given by your internet service provider and enter the numbers.
 - If the number is unknown, then check the number of other devices such as personal computers connected via a LAN cable and assign the same number.
 - If a wrong number is entered, then press [DELETE *].
- 9 Press [◀, ▶] to select "Yes" and press [OK].

Note

- The numeric input range is between 0 and 255.

■ Setting the connection speed

When the connection test results in "Failed" after the IP and DNS-IP addresses are assigned, perform the following settings.

After performing steps 1–5 (⇒ left)

- 6 Press [▲, ▼] to select "Connection Speed Auto-configure" and press [◀, ▶] to select "Off".
- 7 Press [▲, ▼] to select "Connection Speed Setting" and press [◀, ▶] to select a connection speed.
 - Select a connection speed in accordance with the environment of the network connected.
 - When the settings are changed, the network connection may be disabled depending on the device.

■ Setting the proxy server

In most cases, default settings can normally be used without making any changes.

Please use this setting when instructed to by your Internet provider.

- Set the proxy server only after the connection test is completed properly.

- 1 Press [FUNCTION MENU].
- 2 Press [▲, ▼] to select “To Others” and press [OK].
- 3 Press [▲, ▼] to select “Setup” and press [OK].
- 4 Press [▲, ▼] to select “Network Settings” and press [OK].
- 5 Press [▲, ▼] to select “Proxy Server Settings” and press [OK].

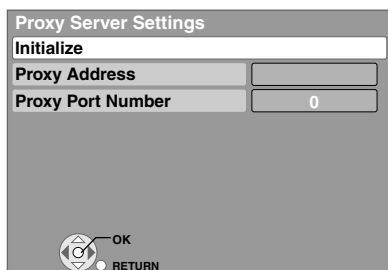

- 6 Press [▲, ▼] to select “Proxy Address” and press [OK].

(⇒ 73, Entering text)

After the input of “Proxy Address” is completed

- 7 Press [▲, ▼] to select “Proxy Port Number” and press [OK].
- 8 Enter numbers with the numbered buttons and press [OK].

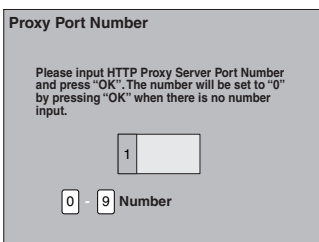

- 9 Press [◀, ▶] to select “Yes” and press [OK].

To set back to default setting

After performing steps 1–5 (⇒ above)

- ① Press [▲, ▼] to select “Initialize” and press [OK].
- ② Press [◀, ▶] to select “Yes” and press [OK].

Television operation

You can configure the remote control TV operation buttons to turn the television on/off, change the television input mode, select the television channel and change the television volume.

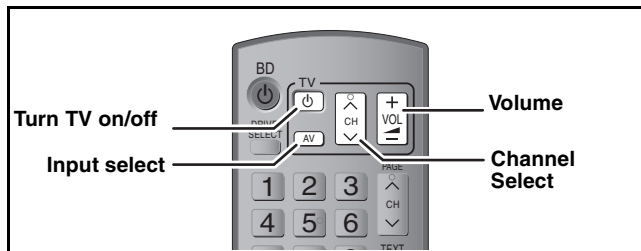

1 Point the remote control at the television While pressing [TV], enter the code with the numbered buttons.

e.g., 01: [0] → [1] 10: [1] → [0]

Manufacturer and Code No.

Brand	Code	Brand	Code
Panasonic	01/02/03/04	METZ	05/28
AIWA	35	MITSUBISHI	05/19/20/47
AKAI	27/30	MIVAR	24
BEJING	33	NEC	36
BEKO	05/71/72/73/74	NOBLEX	33
BENQ	58/59	NOKIA	25/26/27/60/61
BP	09	NORDMENDE	10
BRANDT	10/15	OLEVIA	45
BUSH	05	ONWA	30/39/70
CENTREX	66	ORION	05
CHANGHONG	69	PEONY	49/69
CURTIS	05	PHILCO	41/48/64
DAEWOO	64/65	PHILIPS	05/06/46
DESMET	05	PHONOLA	05
DUAL	05	PIONEER	37/38
ELEMIS	05	PROVIEW	52
FERGUSON	10/34	PYE	05
FINLUX	61	RADIOLA	05
FISHER	21	SABA	10
FUJITSU	53	SALORA	26
FUNAI	63/67	SAMSUNG	32/42/43/65/68
GOLDSTAR	05/50/51	SANSUI	05
GOODMANS	05	SANYO	21/54/55/56
GRADIENTE	36	SCHNEIDER	05/29/30
GRUNDIG	09	SEG	05/69/75/76/77/78
HIKONA	52	SELECO	05/25
HITACHI	05/22/23/40/41	SHARP	18
INNO HIT	05	SIEMENS	09
IRRADIO	30	SINUDYNE	05
ITT	25	SONY	08
JINGXING	49	TCL	31/33/66/67/69
JVC	17/30/39/70	TELEFUNKEN	10/11/12/13/14
KDS	52	TEVION	52
KOLIN	45	TEX ONDA	52
KONKA	62	THOMSON	10/15/44
LG	05/50/51	TOSHIBA	16/57
LOEWE	07/46	WHITE WESTINGHOUSE	05
MAG	52	YAMAHA	18/41

2 Test by turning on the television and changing channels.

- Repeat the procedure until you find the code that allows correct operation.
- If your television brand is not listed or if the code listed for your television does not allow control of your television, this remote control is not compatible with your television.

Note

- If your television brand has more than one code listed, select the one that allows correct operation.

Child Lock

The Child Lock deactivates all buttons on the unit and remote control. Use it to prevent other people from operating the unit.

Press and hold [OK] and [RETURN] simultaneously until “X HOLD” appears on the unit’s display.



If you press a button while the Child Lock is on, “X HOLD” appears on the unit’s display and operation is impossible.

To cancel the Child Lock

Press and hold [OK] and [RETURN] simultaneously until “X HOLD” disappears.

Software of this unit can be updated automatically by following method.

- From broadcasts
- From Internet [network connection and setting is required. (➔ 98)]

Update of the software is done when it is in standby mode. Once the new software is found, it will start the download of the software, and then the upload. Download of the software will start automatically when the power of this unit is turned off or when it is 3 a.m.

- The time it takes to update depends on the connection.
 - For Broadcast: About 2 to 4 hours
 - For Internet: About 1 hour
 (It may take longer than specified above to download because the download time differs depending on the network environment. It is recommended to be used in a broadband environment.)

If you do not want to perform the software update during the standby mode, set the “Software Update in Standby” in the Setup menu to “Off”. (➔ 89)

■ If a software update is available, a notification is displayed.

For broadcast



Software update

- Following screen is displayed when “Red” button is pressed.

For Internet

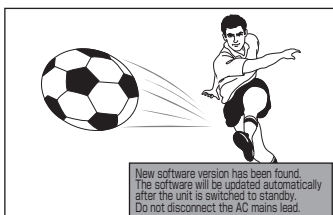

- Update of the software will start when the power is turned off.

■ The unit’s display during the update

- “SW-DL” : Software is downloading. Download will stop when the power is turned on, or the timer recording starts.
- “START”* : Update of the software will start once the download is completed.
- “UPD □/□”* : Software is updating.
- “FINISH” : Updated of the software has completed.

* You cannot operate the unit until the update is complete. Removing the AC mains lead while the update is in progress may damage the unit.

Note

- If the timer recording is scheduled within the following time at the start of the download, the download will not be executed.
 - For broadcast: Within 4 hours
 - For Internet: Within 1 hour
- If downloading on this unit fails or this unit is not connected to the Internet, then you can download the latest software from the following website and burn it to a CD-R to update the software. <http://panasonic.net/support/>

Additional connections

* Leave "Yellow" unconnected.

Connecting a television with S VIDEO terminals

The S VIDEO OUT terminal achieves a more vivid picture than the VIDEO OUT terminal. (Actual results depend on the television.)

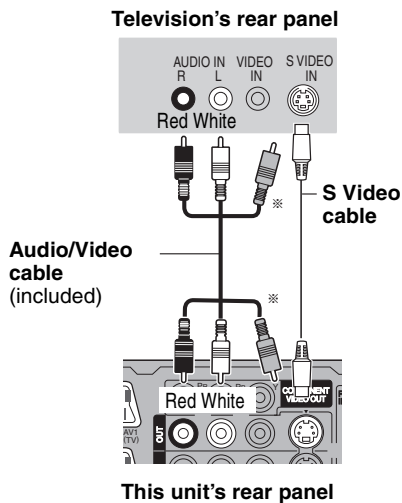

Connecting a stereo amplifier

Amplifier's rear panel

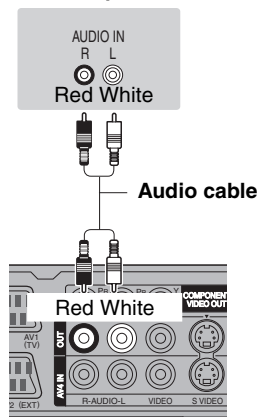

This unit's rear panel

Connecting a television with COMPONENT VIDEO terminals

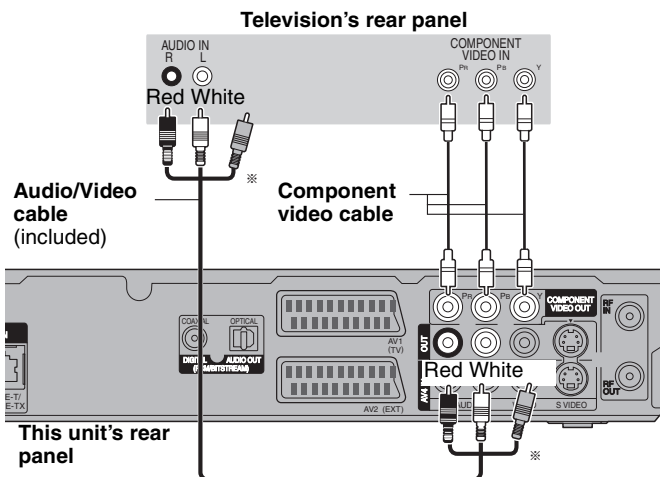

COMPONENT VIDEO terminals can be used for either interlace or progressive output (⇒ 115) and provide a purer picture than the S VIDEO OUT terminal.

• Connect to terminals of the same colour.

Required setting

"Component Resolution" setting in the Setup menu (⇒ 87)

If you have a regular television (CRT: cathode ray tube)

Progressive output may cause some flickering, even if it is progressive compatible. Turn off "Progressive" if you are concerned about it (⇒ 76). This is the same for multi system televisions using PAL mode.

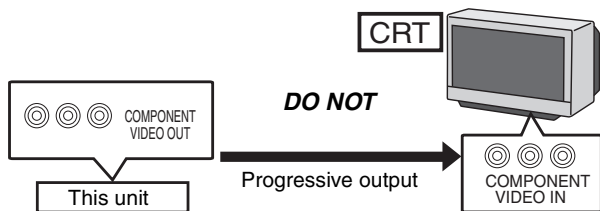

Connecting an amplifier with a digital input terminal

Required setting

"Digital Audio Output" in the Setup menu (⇒ 85)

- When this unit is connected to an amplifier with an optical digital audio cable and connected to a television with an HDMI cable, you can enjoy the highest quality of audio from the disc by setting "HDMI Audio Output" to "Off" in the Setup menu (⇒ 87). In this case audio is only output from the amplifier not the television.
- Before purchasing an optical digital audio cable (not included), check the terminal shape of the connected equipment.

■ With OPTICAL

Amplifier's rear panel

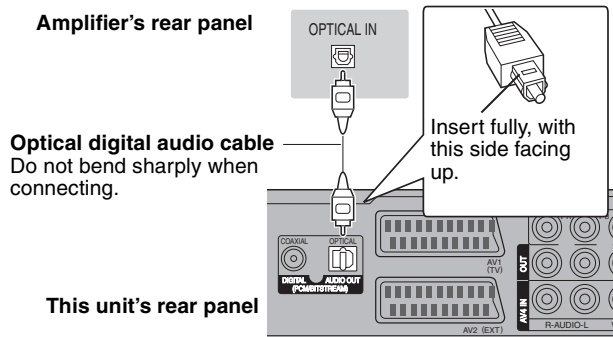

This unit's rear panel

■ With COAXIAL

Amplifier's rear panel

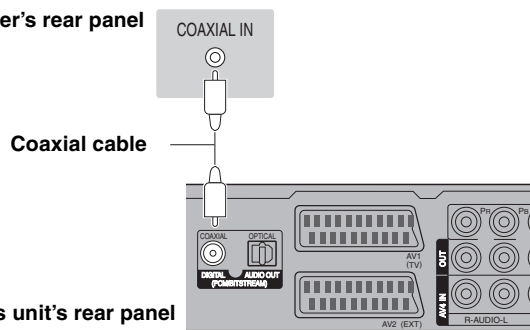

This unit's rear panel

Connecting with an HDMI compatible television and receiver

When connected to an HDMI compatible unit, an uncompressed digital audio and video signal is transmitted. You can enjoy high quality, digital video and audio with just one cord. When connecting to an HDMI-compatible HDTV (High Definition Television), the output can be switched to 1080p, 1080i or 720p HD video.

- Video sources converted to 1920×1080 resolution, while of high quality, will exhibit somewhat lower subjective image resolution than true, native 1080p full-HD sources. See dealer for details.
- Please use High Speed HDMI Cables that have the HDMI logo (as shown on the cover).
- When outputting 1080p signal, please use HDMI Cables 5.0 meters or less.

Regarding VIERA Link “HDAVI Control™” function

When connecting with a Panasonic TV (VIERA) or a receiver equipped with the “HDAVI Control” function, linked operations would be possible. [⇒ 74, Linked operations with the TV (VIERA Link “HDAVI Control™”)]

- **Non-HDMI-compliant cables cannot be utilised.**
- **It is recommended that you use Panasonic’s HDMI cable.**

Recommended part number:

RP-CDHG10 (1.0 m), RP-CDHG15 (1.5 m), RP-CDHG20 (2.0 m), RP-CDHG30 (3.0 m), RP-CDHG50 (5.0 m), etc.

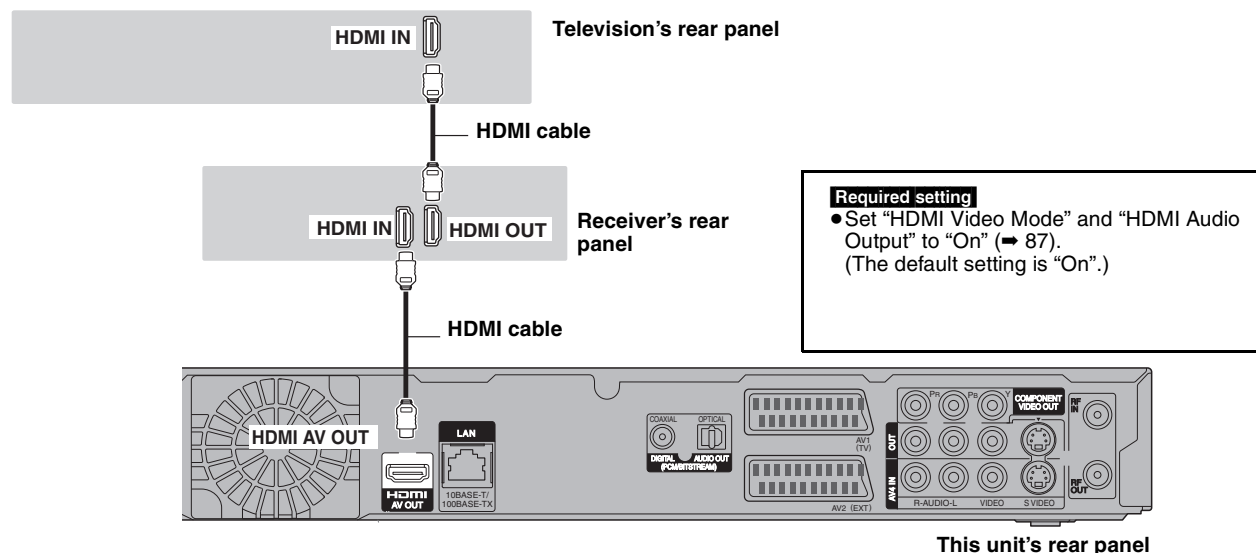

Note

- If you are connecting to a TV that is only compatible with 2 channel audio output, audio with 3 channels or more will be down mixed (⇒ 114) and output as 2 channels, even if connecting with an HDMI cable. (Some discs cannot be down mixed.)
- You cannot connect this unit to DVI devices that are incompatible with HDCP.

For units compatible with HDCP (High-Bandwidth Digital Content Protection) copyright protection that are equipped with a digital DVI input terminal (PC monitors, etc.):

Depending on the unit, images may not display properly or at all when connecting with a DVI/HDMI switching cable. (Audio cannot be output.)

Connecting an Analogue television and VCR

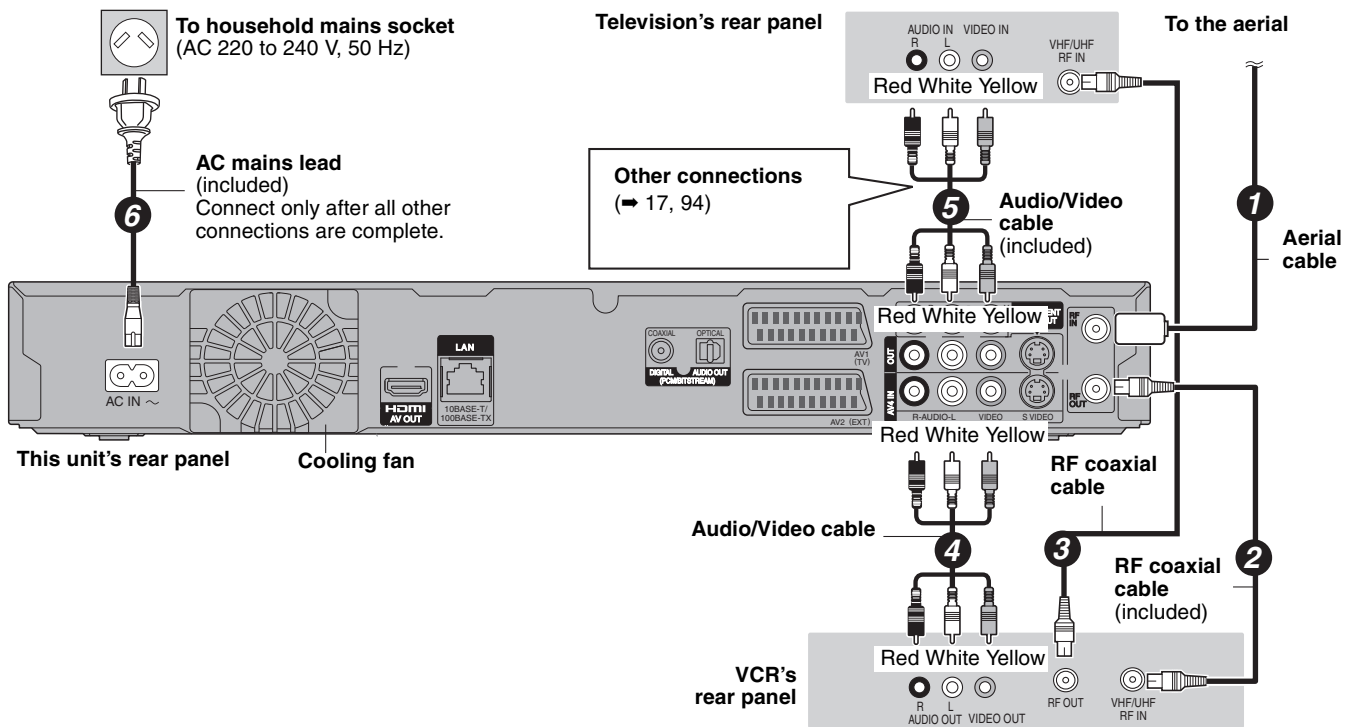

Connecting a Digital television and VCR

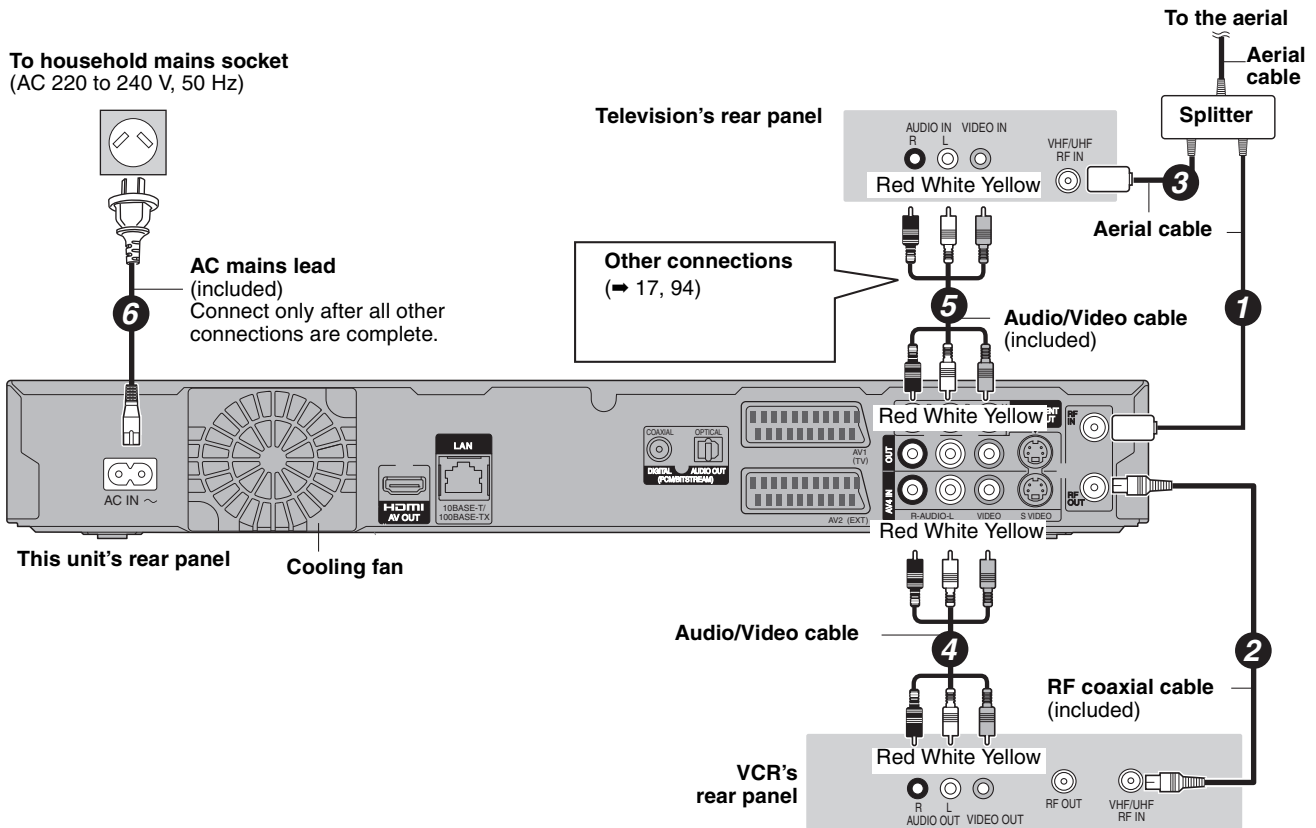

Additional connections

Connect the unit directly to the television
If you connect the unit through an AV selector or video cassette recorder to the television, video signal will be affected by copyright protection systems and the picture may not be shown correctly.

When connecting to a television with a built-in VCR
Connect to the input terminals on the television side if there are both television and VCR input terminals.

DO NOT

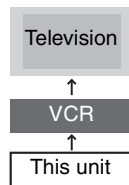

Connecting to a television with 21-pin Scart terminal
You can also connect with the AV1 terminal on this unit using the 21-pin Scart cable.
If your television is equipped with RGB input capability, by connecting with a fully wired 21-pin Scart cable you can see video using RGB output on this unit.

Required setting
"AV1 Output" in the Setup menu (→ 88)

Connecting to a VCR with 21-pin Scart terminal
You can also connect with the AV2 terminal on this unit using the 21-pin Scart cable.

Required setting
"AV2 Input" in the Setup menu (→ 88)

Network connection

Following function will be available when this unit is connected to the network.

- This document is assuming that you already have a broadband connection.
- This connection is not necessary if following functions are not to be used.

Automatically acquire the title of the CD	Automatically acquire the title of the CD or the information about the artist. (⇒ 71)
Update the software of this unit	Automatically update the software of this unit. (⇒ 93) <ul style="list-style-type: none"> • Update of the software can be done from the broadcast too.

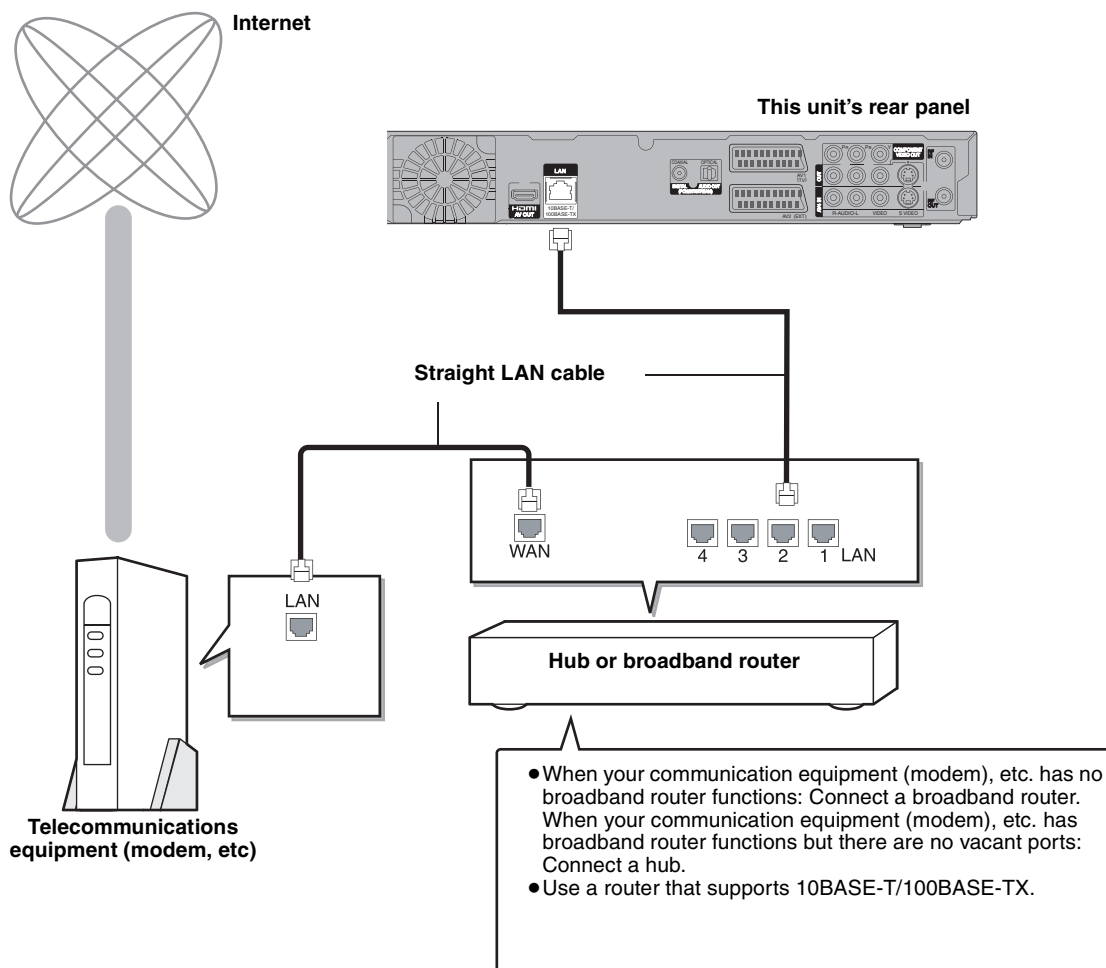

- Make the necessary settings in “Network Settings” after connecting. (⇒ 90)

Note

- Refer to the operating instructions for the connected device.
- It may not work properly depending on the equipment or environment used.
- Depending on the contract with the provider, you may not be able to connect multiple numbers of terminals such as this unit or computers, or an additional fee might be required.
- Use only shielded LAN cables when connecting to peripheral devices.

Operations that can be performed while recording or copying a title

(○: Possible, -: Impossible)

	Playback of HDD	Playback of discs	Playback of BD-Video	Playback of still pictures	Playback of music recorded on HDD
While recording to HDD in DR mode	○	○	○	-	○
While recording to HDD in XP, SP, LP, EP, or FR modes	○	○*	-	-	○
While timer recording to disc	○	-	-	-	○
While recording from DV input	-	-	-	-	-
While copying using "Copy"	-	-	-	-	-
While copying in normal speed mode	-	-	-	-	-
While copying in high speed mode (With finalising)	-	-	-	-	-
While copying in high speed mode (Without finalising)	○	-	-	-	-

*AVCHD It cannot playback.

• Simultaneous operation is not possible while executing the "DV Auto Rec" or "Recording via AV3 input".

Starting of the timer recording while executing other operation

Starting of timer recording possible during the following operations	Starting of timer recording not possible during the following operations
<ul style="list-style-type: none"> ● Recording the title^{*1} ● Playing the title^{*2} ● Editing the title ● Copying a title in high speed mode (without finalising) <ul style="list-style-type: none"> - Only 1 programme can be recorded ● Executing "DV Auto Rec"^{*3} ● Executing "Recording via AV3 input"^{*3} ● Executing Pause Live TV^{*1} <p>^{*1} Executing operation will terminate when 2 programme simultaneous recording cannot be performed.</p> <p>^{*2} Playback of disc will terminate when the timer recording to disc is started while playing back from the disc or when the timer recording other than the DR mode has started while playing BD-Video.</p> <p>^{*3} Executing operation will be terminated.</p>	<ul style="list-style-type: none"> ● Copying a title in normal speed mode ● Copying a title in high speed mode (with finalising) ● Copying HD Video (AVCHD format) ● Editing still pictures or music ● Copying still pictures ● Copying music ● Formatting ● Finalising

Frequently asked questions

Refer to the following items if you have any doubts about unit operations.

Set up		Page
Which aerial is suitable for receiving digital terrestrial broadcasts?	<ul style="list-style-type: none"> You can use your current aerial. However, depending on the area where you live, a new aerial may be necessary. Consult your local TV aerial installer. 	—
Can this unit receive or record High Definition (HD) broadcasts?	<ul style="list-style-type: none"> Yes, this unit can receive or record High Definition (HD) broadcasts. Record in DR recording mode. 	—
What do I need to play multi channel surround sound?	<ul style="list-style-type: none"> Connect the appropriate amplifier/receiver to the HDMI AV OUT terminal, the DIGITAL AUDIO OUT terminal (OPTICAL, COAXIAL). 	94, 95
Are the headphones and speakers directly connected to the unit?	<ul style="list-style-type: none"> You cannot directly connect them to the unit. Connect through the amplifier etc. 	94, 95
My television has S VIDEO IN terminal, COMPONENT VIDEO IN terminals and HDMI IN terminal. Which should I connect with?	<ul style="list-style-type: none"> The different levels of picture quality input are listed below in order from highest to lowest. HDMI IN→COMPONENT VIDEO IN→S VIDEO IN→VIDEO IN. However, it will take longer for the picture output to start up when this unit is connected with the HDMI IN terminal. 	—
Disc		
Can I play BD-Video and DVD-Video bought in another country?	<ul style="list-style-type: none"> Playback of the following discs is not possible. <ul style="list-style-type: none"> BD-Video discs that do not include region "B". DVD-Video discs that do not include region "4" or "ALL". Refer to the disc's jacket for more information. 	Cover
Can BD-Video/DVD-Video that does not have a region code/number be played?	<ul style="list-style-type: none"> The region management information for BD-Video/DVD-Video indicates that the disc conforms to industry standards. You cannot play discs that do not conform to industry standards or do not have a region code or number. 	—
Please tell me about disc compatibility with this unit.	<ul style="list-style-type: none"> Refer to "HDD and disc information". 	6–10
Recording		
Can I record from a commercially purchased video cassette, BD or DVD?	<ul style="list-style-type: none"> Most commercially sold video cassettes, BD and DVD are copy protected; therefore, recording is usually not possible. 	—
Can the disc recorded with this unit play on other equipment?	<ul style="list-style-type: none"> Refer to "Play on other players" in "HDD and disc information". 	8–9
Can I high speed copy to a disc?	<ul style="list-style-type: none"> Yes, you can. (But you may not high speed copy depending on the disc to copy or the title.) Depending on the disc type, the maximum speed varies. 	50
Is it possible to copy to the disc, SD card, or USB memory after copying HD video (AVCHD format) to the HDD?	<ul style="list-style-type: none"> It can be copied to the disc. <ul style="list-style-type: none"> BD-RE BD-R It can be copied with HD quality. RAM -R -R DL -RW(V) +R +R DL +RW It will be copied with SD quality. (It cannot be copied as it is in HD picture quality.) It cannot be copied to SD card or USB memory. 	—

TV Guide

Page

Is it possible to programme a recording, with a start and end time that are different from the TV Guide system?	<ul style="list-style-type: none"> You can manually change the start and end time of programmes in the Timer Recording menu. 	34
Can I receive TV Guide system data via a connected satellite receiver or a Set Top Box?	<ul style="list-style-type: none"> No, only via the built-in tuner. 	—
How can I cancel a TIMER programming?	<ul style="list-style-type: none"> Press [PROG/CHECK] and select the desired entry and then press [DELETE *]. 	36
What happens when I unplug the unit from the household mains socket?	<ul style="list-style-type: none"> The TV Guide data will not be updated. If the unit is disconnected from the household mains socket for a longer period of time, the TV Guide data will be lost. Clock setting will be erased and timer recording will not work. 	— — —

USB

What can or cannot be done using the USB port on this unit?	<ul style="list-style-type: none"> You can play MP3 or still picture (JPEG) files on a USB memory. You can copy still pictures (JPEG) files on a USB memory to the HDD. You can copy MP3 files on a USB memory to the HDD. You can connect a video equipment and copy SD Video to the HDD or DVD-RAM. You can connect a video equipment and copy HD Video to the HDD, BD-RE or BD-R. Data on the HDD or a disc cannot be transferred to a USB memory. Data on a USB memory cannot be edited or a USB memory cannot be formatted on this unit. Some USB memories cannot be used with this unit. 	60, 66 64 71 59 58 — — 11
---	--	--

Music

What will happen if I try to record the same CD multiple times?	<ul style="list-style-type: none"> New album will be made following the existing album. 	—
Can I transfer the music tracks from HDD to the disc or USB memory?	<ul style="list-style-type: none"> No, you cannot. 	—

Regarding Frequently asked questions for copying (⇒ 50)

Language code list Enter the code with the numbered buttons.

Abkhazian: 6566	Catalan: 6765	Gujarati: 7185	Lingala: 7678	Rhaeto-Romance: 8277	Tamil: 8465
Afar: 6565	Chinese: 9072	Hausa: 7265	Lithuanian: 7684	Tatar: 8484	Telugu: 8469
Afrikaans: 6570	Corsican: 6779	Hebrew: 7387	Macedonian: 7775	Romanian: 8279	Thai: 8472
Albanian: 8381	Croatian: 7282	Hindi: 7273	Malagasy: 7771	Russian: 8285	Tibetan: 6679
Amharic: 6577	Czech: 6783	Hungarian: 7285	Malay: 7783	Samoan: 8377	Tigrinya: 8473
Arabic: 6582	Danish: 6865	Icelandic: 7383	Malayalam: 7776	Sanskrit: 8365	Tonga: 8479
Armenian: 7289	Dutch: 7876	Indonesian: 7378	Maltese: 7784	Scots Gaelic: 7168	Turkish: 8482
Assamese: 6583	English: 6978	Interlingua: 7365	Maori: 7773	Serbian: 8382	Turkmen: 8475
Aymara: 6589	Esperanto: 6979	Irish: 7165	Marathi: 7782	Serbo-Croatian: 8372	Twi: 8487
Azerbaijani: 6590	Estonian: 6984	Italian: 7384	Moldavian: 7779	Shona: 8378	Ukrainian: 8575
Bashkir: 6665	Faroese: 7079	Japanese: 7465	Mongolian: 7778	Sindhi: 8368	Urdu: 8582
Basque: 6985	Fiji: 7074	Javanese: 7487	Nauru: 7865	Singhalese: 8373	Uzbek: 8590
Bengali, Bangla: 6678	Finnish: 7073	Kannada: 7578	Nepali: 7869	Slovak: 8375	Vietnamese: 8673
Bhutani: 6890	French: 7082	Kashmiri: 7583	Norwegian: 7879	Slovenian: 8376	Volapük: 8679
Bihari: 6672	Frisian: 7089	Kazakh: 7575	Oriya: 7982	Somali: 8379	Welsh: 6789
Breton: 6682	Galician: 7176	Kirghiz: 7589	Pashto, Pushto: 8083	Spanish: 6983	Wolof: 8779
Bulgarian: 6671	Georgian: 7565	Korean: 7579	Persian: 7065	Sundanese: 8385	Xhosa: 8872
Burmese: 7789	German: 6869	Kurdish: 7585	Polish: 8076	Swahili: 8387	Yiddish: 7473
Byelorussian: 6669	Greek: 6976	Laotian: 7679	Portuguese: 8084	Swedish: 8386	Yoruba: 8979
Cambodian: 7577	Greenlandic: 7576	Latin: 7665	Punjabi: 8065	Tagalog: 8476	Zulu: 9085
	Guarani: 7178	Latvian, Lettish: 7686	Quechua: 8185	Tajik: 8471	

On the television

Page

Cannot finish recording completely.	<ul style="list-style-type: none"> • The programme was copy-protected. • The HDD or disc may be full. • The maximum number of programme has been exceeded. 	— — 31
Cannot playback. TV system is different from the setting. To playback, please change the TV System in Setup.	<ul style="list-style-type: none"> • You tried to play a title recorded using a different encoding system from that of the TV system currently selected on the unit. Alter the “TV System” setting on this unit to suit. 	87
Cannot record to the disc.	<ul style="list-style-type: none"> • The disc may be dirty or scratched. 	15
Cannot format.		
Cannot play on this unit.	<ul style="list-style-type: none"> • You tried to play a non-compatible image. • Turn the unit off and re-insert the card. 	113 15
Cannot record. Disc is full.	<ul style="list-style-type: none"> • HDD BD-RE RAM -RW(V) +RW Create space by deleting any unnecessary titles. [Even if you delete recorded content from the BD-R, DVD-R, DVD-R DL, +R or +R DL there is no increase in disc space. Available space on DVD-RW (DVD-Video format) and +RW increases only when the last recorded title is deleted.] • Use a new disc. 	26, 45, 80
Cannot record. Exceeds maximum number limit of titles allowed.		—
No Disc	<ul style="list-style-type: none"> • The disc may be upside down. 	—
No folders.	<ul style="list-style-type: none"> • There is no compatible folder in this unit. 	115
No SD CARD No valid SD card.	<ul style="list-style-type: none"> • The card is not inserted. If this message is displayed with a compatible card already inserted, turn off the unit, remove and then re-insert the card. • The card inserted is not compatible or the card format does not match. 	15
		113
Not enough space in the copy destination.	<ul style="list-style-type: none"> • Create space by deleting any unnecessary items. • Delete one or more items registered on the copy list to ensure that the “Destination Capacity” is not exceeded. 	26, 45, 80
		53, 65
The disc is not recordable.	<ul style="list-style-type: none"> • The unit cannot record on the disc you inserted. Insert an unfinalised disc. • You inserted an unformatted disc. 	—
This disc is not formatted properly.		80
⊘ This operation cannot be performed now.	<ul style="list-style-type: none"> • The operation is prohibited by the unit or disc. 	—

When removing a recorded disc

-R -R DL -RW(V) +R +R DL

The following screen appears when you have not processed the disc for play on other equipment.

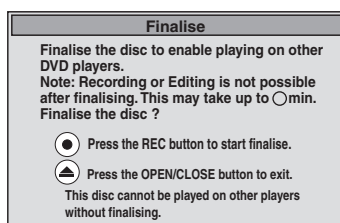

■ To finalise the disc

Press [● REC] on the main unit.

- You cannot stop this process once you have started it.
- If you want to set the background, play menu select or provide a disc name, select “Top Menu” (⇒ 81), “Auto-Play Select” (⇒ 81) or “Disc Name” (⇒ 79) in “DVD Management” before finalising.

■ To open the tray without disc finalisation

Press [▲ OPEN/CLOSE] on the main unit.

On the unit's display

The following messages or service numbers appear on the unit's display when something unusual is detected during startup and use.

		Page
BD □ ("□" stands for a number.)	<ul style="list-style-type: none"> The remote control and main unit are using different codes. Change the code on the remote control.  <p>Press and hold [OK] and the indicated number button at the same time for more than 5 seconds.</p>	89
FINISH	<ul style="list-style-type: none"> The software update is complete. 	93
HARD ERR	<ul style="list-style-type: none"> If there is no change after turning the unit on and off, consult the dealer where the unit was purchased. 	—
NoERAS	<ul style="list-style-type: none"> You cannot delete items on this disc. The disc may be damaged. Use a new disc. 	—
NoREAD	<ul style="list-style-type: none"> The disc is dirty or badly scratched. The unit cannot record, play, or edit. This message may appear when the lens cleaner has finished cleaning. Press [▲ OPEN/CLOSE] on the main unit to eject the disc. 	15 14
NoWRIT	<ul style="list-style-type: none"> You cannot write to this disc. The disc may be damaged. Use a new disc. 	—
PLEASE WAIT	<ul style="list-style-type: none"> Displayed when the unit is started and turn off. This is not malfunction. There was a power failure or the AC plug was disconnected while the unit was on. The unit is carrying out its recovery process. This process restores the unit to normal operation. The unit is not broken. Wait until the message disappears. 	— —
PROG FULL	<ul style="list-style-type: none"> There are already 32 timer programmes. Delete unnecessary timer programmes. 	36
REMOVE	<ul style="list-style-type: none"> The USB device is drawing too much power. Remove the USB device. 	—
START	<ul style="list-style-type: none"> Update of the software is started. You cannot operate the unit until the update is complete. 	93
SW-DL	<ul style="list-style-type: none"> Software is downloading. Download will stop when the power is turned on, or the timer recording starts. 	93
UNFORMAT	<ul style="list-style-type: none"> You inserted an unformatted BD-RE, BD-R, DVD-RAM, DVD-RW, +RW, an unused +R, +R DL, or DVD-RW (DVD-Video format) that has been recorded on other equipment. Format the disc to use it. However all the recorded contents on the disc are deleted. 	80
UNSUPPORT	<ul style="list-style-type: none"> You have inserted a disc the unit cannot play or record on. You tried to operate with a non-compatible USB memory. 	8–10 11
UPD □/□	<ul style="list-style-type: none"> The software is being updated. You cannot operate the unit until the update is complete. 	93
U59	<ul style="list-style-type: none"> The unit is hot. The unit switches to standby for safety reasons. Wait for about 30 minutes until the message disappears. Select a position with good ventilation when installing the unit. Do not block the cooling fan on the rear of the unit. 	—
U61	<ul style="list-style-type: none"> (When a disc is not inserted) Displays when a malfunction has occurred during recording, playback or copy. This is displayed when the unit is in the recovery process to return to normal operation; it is not broken. Once the display clears you can use the unit again. 	—
U72 U73	<ul style="list-style-type: none"> The HDMI connection acts unusually. <ul style="list-style-type: none"> The connected equipment is not HDMI compatible. Please use HDMI cables that have the HDMI logo (as shown on the cover). The HDMI cable is damaged. 	—
U76	<ul style="list-style-type: none"> HDMI cannot be output because you are connected to a model that does not support copyright protection. 	—
U77	<ul style="list-style-type: none"> Due to the current disc not having authorised copyright information, video output is not performed. 	—
U88	<ul style="list-style-type: none"> (When a disc is inserted) Displays when there was something unusual detected with the disc while recording, playback or copy. This is displayed when the unit is in the recovery process to return to normal operation; it is not broken. Once the display clears you can use the unit again. 	104
U99	<ul style="list-style-type: none"> The unit fails to operate properly. Press [⏻] on the main unit to switch the unit to standby mode. Now press [⏻] on the main unit again to turn the unit on. 	—
H □□ or F □□	<ul style="list-style-type: none"> There is something unusual. (The service number displayed after H and F depends on the unit's condition.) Check the unit using the troubleshooting guide. If the service number does not disappear, do the following. <ol style="list-style-type: none"> Disconnect the plug from the household mains socket, wait a few seconds, then reconnect it. Press [⏻] to turn the power on. (The unit may be fixed.) If the service number does not disappear despite after doing the above, request service from the dealer. Inform the dealer of the service number when requesting service. 	— 104– 111
X HOLD	<ul style="list-style-type: none"> The Child Lock function is activated. Press and hold [OK] and [RETURN] at the same time until "X HOLD" disappears. 	92

Troubleshooting guide

Before requesting service, make the following checks. If you are in doubt about some of the check points, or if the solutions indicated in the chart do not solve the problem, consult your dealer for instructions.
Updating to the latest software may solve the problem. (➔ 93)

The following do not indicate a problem with this unit:

- | | |
|---|--|
| <ul style="list-style-type: none"> ● Regular disc rotating sounds. ● Poor reception due to atmospheric conditions. ● Image disturbance during search. ● Interruptions in reception due to periodic terrestrial broadcasting breaks. ● Operations are slow to respond in power save mode. ● Operations do not work due to a poor-quality disc. (Try again using a Panasonic disc.) | <ul style="list-style-type: none"> ● The unit freezes due to one of its safety devices being activated. (Press and hold [⏻/⏪] on the main unit for 10 seconds.) ● When the unit is turned on or off, there may be an unexpected sound. This does not indicate a problem with this unit. |
|---|--|

Power

Page

No power. The unit does not turn on pressing [⏻ BD].	● Insert the AC mains lead securely into a known active household mains socket.	16, 96, 97
The unit switches to standby mode.	● One of the unit's safety devices is activated. Press [⏻/⏪] on the main unit to turn the unit on.	—
The power is turned off automatically.	● If you connected this unit to a "HDMI Control" compatible TV with an HDMI cable, this unit will be automatically set to standby mode when the TV is set to standby mode.	74

Displays

The display is dim.	● Change "FL Display" in the Setup menu.	86
"0:00" is flashing on the unit's display.	● Set the clock.	89
The time recorded on the disc and the available time shown do not add up. The displayed time of this unit is different from the actual recording time.	<ul style="list-style-type: none"> ● Times shown may disagree with actual times. ● Available recording space on DVD-RW (DVD-Video format) or +RW increases only when the last recorded title is deleted. It does not increase if other titles are deleted. ● Even if you delete recorded content from the BD-R, DVD-R, DVD-R DL, +R or +R DL, there is no increase in disc space. ● More disc space than the actual recording time is used after recording or editing the DVD-R, DVD-R DL, +R or +R DL 200 times or more. ● While searching, the elapsed time may not display correctly. 	—
Compared to the actual recorded time, the elapsed time displayed is less. (Only when recording in NTSC)	● The displayed recording/play time is converted from the number of frames at 29.97 frames (equal to 0.999 seconds) to one second. There will be a slight difference between the time displayed and the actual elapsed time (e.g., actual one-hour elapsed time may display as approximately 59 minutes 56 seconds). This does not affect the recording.	—
Available disc space display is showing different from what was used	● Available disc space display may be different from actual. Varying may be large especially when recorded in DR mode.	—
"U88" is displayed and the disc cannot be ejected.	<ul style="list-style-type: none"> ● The unit is carrying out the recovery process. Do the following to eject the disc. <ol style="list-style-type: none"> 1 Press [⏻/⏪] on the main unit to switch the unit to standby. If the unit doesn't switch to standby, press and hold [⏻/⏪] on the main unit for about 10 seconds. The unit is forcibly switched to standby. 2 While the unit is off, press and hold [■] and [CH ^] on the main unit at the same time for about 5 seconds. Remove the disc. 	—

Television reception worsens after connecting the unit.	<ul style="list-style-type: none"> This can occur because the signals are being divided between the unit and other equipment. It can be solved by using a signal booster, available from audio-visual suppliers. If it is not solved by using a signal booster, consult the dealer. 	—
The digital channel information or control panel does not appear.	<ul style="list-style-type: none"> Select the length of time (3–10 sec.) that the “On-Screen Messages” in the Setup menu will be displayed. The digital channel information will not appear during playback or recording. The control panel is only displayed when connected to a TV with “HDAVI Control 2” or “HDAVI Control 3” function. 	86 — 75
Picture does not appear during timer recording.	<ul style="list-style-type: none"> Timer recordings work regardless whether the unit is on or off. To confirm the timer recording is going to work properly, turn the unit on. 	—
The 4:3 aspect ratio picture expands left and right.	<ul style="list-style-type: none"> Check the following setting in the Setup menu. <ul style="list-style-type: none"> – “TV Aspect”, “Aspect for 4:3 Video” If it is connected with COMPONENT VIDEO OUT terminal, set the “Progressive” in Picture menu to “Off”. If it has no effect or you cannot set to “Off”, set the “Component Resolution” in Setup menu to “576i/480i” and “HDMI Video Mode” to “Off”. 	87 76, 87
Screen size is wrong.	<p>It may be possible to adjust the display mode on the TV. Refer to your television’s operating instructions.</p>	—
The screen changes automatically.	<ul style="list-style-type: none"> If there is no operation for 10 minutes or more, the displayed screen switches to the other states automatically. (only when the “Screen Saver” in Setup menu is set to “On”.) 	86
The recorded title is stretched vertically.	<ul style="list-style-type: none"> It may have been recorded with 4:3 aspect ratio. You will be able to view in 16:9 aspect ration by setting the “TV Aspect” in Setup menu to “16:9”. It may be possible to adjust the display mode on the TV. Refer to your television’s operating instructions. If the 16:9 aspect ratio image is output to a 4:3 TV connected with the COMPONENT VIDEO OUT terminal or the HDMI AV OUT terminal, it will be stretched vertically. Adjust by the aspect ratio setting on the TV. If you cannot make the adjustment, set the “Component Resolution” in the Setup menu to “576p/480p” and “HDMI Video Format” to “576p/480p”. 	87 87
There is a lot of after-image when playing video.	<ul style="list-style-type: none"> Set “HD optimizer” in the Picture menu to “Off”. 	76
When playing DVD-Video using progressive output, one part of the picture momentarily appears to be doubled up.	<ul style="list-style-type: none"> Set “Progressive” in the Picture menu to “Off”. This problem is caused by the editing method or material used on DVD-Video, but should be corrected if you use interlace output. 	76
There is no apparent change in picture quality when adjusted with the Picture menu in the on-screen menus.	<ul style="list-style-type: none"> The effect is less perceivable with some types of video. 	—
The images from this unit do not appear on the television.	<ul style="list-style-type: none"> Make sure that the television is connected to the VIDEO OUT terminal, S VIDEO OUT terminal, COMPONENT VIDEO OUT terminals or HDMI terminal on this unit. 	16, 17, 94, 95, 96, 97
Picture is distorted.	<ul style="list-style-type: none"> Make sure that the television’s input setting is correct. Progressive output is set to on but the connected television is not progressive compatible. Press and hold [■] and [▶] (PLAY) on the main unit at the same time for more than 5 seconds to cancel this setting. The setting will change to interlace. The unit’s “TV System” setting differs from the TV system used by the disc now playing. While stopped, keep pressing [■] and [▲ OPEN/CLOSE] on the main unit for 5 or more seconds. The system switches from PAL to NTSC or vice versa. When this unit is connected with an HDMI cable, use a disc that matches with this unit’s TV system. Picture may not be seen when more than 4 devices are connected with HDMI cables. Reduce the number of connected devices. 	— — 87 — —
The picture is distorted during play, or video will not play correctly.	<ul style="list-style-type: none"> You may be playing a TV programme recorded with poor reception or unfavourable weather conditions. The picture may be distorted or a black screen may appear briefly between recorded titles in the following situations: <ul style="list-style-type: none"> – between titles recorded with different recording modes. – between scenes recorded with different aspect ratios. – between scenes recorded with different resolutions. – between playlist chapters. 	— —

Sound		Page
No sound. Low volume. Distorted sound. Cannot hear the desired audio type.	<ul style="list-style-type: none"> ● Check the connections and the “Digital Audio Output” settings. Check the input mode on the amplifier if you have connected one. ● Press [AUDIO] to select the audio. ● Turn the “Sound Effects” in the Sound menu to “Off” in the following cases. <ul style="list-style-type: none"> – When using discs that do not have surround sound effects such as Karaoke discs. – When playing bilingual broadcast titles. ● Audio may not be heard when more than 4 devices are connected with HDMI cables. Reduce the number of connected devices. ● The sound effects will not work when the bitstream signal is output from the HDMI AV OUT terminal or the DIGITAL AUDIO OUT terminal. ● To output audio from a device connected with an HDMI cable, set “HDMI Audio Output” to “On” in the Setup menu. ● Depending on the connected equipment, the sound may be distorted if this unit is connected with an HDMI cable. ● When “BD-Video Secondary Audio” is set to “On”, Dolby Digital Plus, Dolby TrueHD, and DTS-HD are converted to 48 kHz Dolby Digital and output. In this case, set the “BD-Video Secondary Audio” to “Off”. 	16, 17, 85, 94, 95, 96, 97 39 77 — — 87 — 85
	Cannot switch audio. <ul style="list-style-type: none"> ● You cannot switch the audio in the following cases. <ul style="list-style-type: none"> – When the recording mode is XP and “Audio Mode for XP Recording” is set to “LPCM”. – When “Rec for High Speed Copy” is set to “On”. (The default setting is “On”). ● The amplifier is connected using an optical digital cable, a coaxial cable or an HDMI cable. You cannot switch the audio if “Digital Audio Output” is set to “Bitstream”. Set “Digital Audio Output” to “PCM” or connect using audio cables. ● There are discs for which audio cannot be changed because of how the disc was created. 	86 84 85, 94, 95 —
Operation		
Cannot operate the television. The remote control doesn’t work.	<ul style="list-style-type: none"> ● Change the manufacturer code. Some televisions cannot be operated even if you change the code. ● The remote control and main unit are using different codes. Change the code on the remote control.  <p>Press and hold [OK] and the indicated number button at the same time for more than 5 seconds.</p>	92 89
	<ul style="list-style-type: none"> ● The batteries are depleted. Replace them with new ones. ● You are not pointing the remote control at the main unit’s remote control signal sensor during operation. ● Coloured glass may obstruct the signal reception/transmission. ● Don’t place the signal sensor in direct sunlight or in areas that may be subject to sunlight exposure. ● Software is updating when “UPD □/□” is displaying on the unit’s display. Wait until the update is completed. ● It may be necessary to set the code on the remote control again after changing the batteries. ● It may be necessary to set the manufacturer code again after changing the batteries. ● The child lock function is activated. 	12 12 — — 93 89 92 92
The unit is on but cannot be operated.	<ul style="list-style-type: none"> ● Recording drive or playback drive has not been selected properly. ● Some operations may be prohibited by the disc. ● The unit is hot (“U59” appears on the display). Wait for “U59” to disappear. ● One of the unit’s safety devices may have been activated. <p>Reset the unit as follows:</p> <ol style="list-style-type: none"> 1 Press [⏻/⏪] on the main unit to switch the unit to standby. If the unit doesn’t switch to standby, press and hold [⏻/⏪] on the main unit for about 10 seconds. The unit is forcibly switched to standby. Alternatively, disconnect the AC mains lead, wait one minute, then reconnect it. 2 Press [⏻/⏪] on the main unit to switch it on. If the unit still cannot be operated, consult the dealer. 	— — — —
Cannot eject disc.	<ul style="list-style-type: none"> ● The unit is recording. ● The unit may have a problem. While the unit is off, press and hold [■] and [CH ^] on the main unit at the same time for about 5 seconds. Remove the disc and consult the dealer. If the Child Lock function is activated, above operation does not work. Cancel the Child Lock function. 	— 92
Cannot tune channels.	<ul style="list-style-type: none"> ● Check the connections. 	16, 96, 97
Cannot download channel presets from the television.	<ul style="list-style-type: none"> ● You must connect to a VIERA Link (HDAVI Control 3) compatible TV with a HDMI cable to download channel presets. 	—
Startup is slow.	<ul style="list-style-type: none"> ● Make sure that “Quick Start” is set to “On”. ● Startup takes time in the following situations: <ul style="list-style-type: none"> – A disc other than a DVD-RAM is inserted. – The clock is not set. – Immediately after a power failure or the AC mains lead is connected. – When the unit is connected with an HDMI cable. 	89 —

<p>Cannot record. Cannot copy.</p>	<ul style="list-style-type: none"> You can not record to the disc by pressing the [● REC]. BD-RE with a cartridge cannot be recorded or copied. You haven't inserted a disc or the disc you inserted cannot be recorded on. Insert a disc the unit can record onto. The disc is unformatted. Format the disc. BD-RE BD-R RAM -RW(V) +R +R DL +RW The disc is protected with DVD Management or BD Management. Some programmes have limitations on the number of times they can be recorded (CPRM). You cannot record when there is not enough space or when the number of titles has reached its limit. Delete unwanted titles or use a new disc. -R -R DL -RW(V) +R +R DL +RW In the following situations, you cannot copy. Delete unnecessary titles from the HDD and then copy. <ul style="list-style-type: none"> If there is not enough space available on the HDD (If you will copy titles from the HDD to a blank disc and fill the entire disc, HDD disc space equivalent to 4 hours of SP mode recording is necessary). If the number of recorded titles and the number of titles to be copied has exceeded 499. You cannot record and copy on finalised discs. However, you can record and copy again if you format BD-RE and DVD-RW. Due to peculiarities of DVD-R, DVD-R DL, DVD-RW (DVD-Video format), +R, +R DL and +RW you may be unable to record onto or edit them if you either insert and remove the disc or switch the unit on and off while a disc is loaded, a total of 30 times. The discs recorded on this unit may not be recordable on other Panasonic Recorders. Discs recorded on equipment other than this unit may not be able to be recorded to. This unit cannot record NTSC signals to discs that already have PAL signal recordings. (However, both types of programmes can be recorded onto the HDD, BD-RE or BD-R.) Play of discs recorded with both PAL and NTSC on another unit is not guaranteed. Some broadcasts are copyright protected. 	<p>— — 8, 9 80 79 114 26, 45, 80, 84 26, 45, 84 — — — — — — —</p>
<p>Cannot record from external equipment.</p>	<ul style="list-style-type: none"> Check that the connection is correct. Select the input channel for the equipment you have connected. "One time only recording" title recorded to HDD from the equipment connected to the external input cannot be copied to BD-RE or BD-R due to the copyright protection regulations. Use the DVD-RAM compatible with the CPRM. 	<p>55, 56, 96, 97 — —</p>
<p>Cannot record 2 programmes simultaneously.</p>	<ul style="list-style-type: none"> It cannot in following conditions. <ul style="list-style-type: none"> Record 2 digital broadcasting programmes in other than DR mode Record 2 programmes from external input Record 2 programmes to disc When performing high speed copying (1 programme can be recorded to HDD) Recording from DV input, while "Recording via AV3 input" 	<p>—</p>
<p>Timer recording does not work properly.</p>	<ul style="list-style-type: none"> The timer programme is incorrect or different timer programme times overlap (is displayed). Correct the programme. The programme is not in timer recording standby. (The timer icon "⊙" in the timer recording is grey.) Set the clock. The programme information in the TV Guide system may not be correct. It is recommended to modify the start and end times to allow a margin of a few minutes. 	<p>36 35 89 34</p>
<p>Cannot timer record to the disc.</p>	<ul style="list-style-type: none"> It cannot timer record in following conditions. <ul style="list-style-type: none"> Unformatted disc <ul style="list-style-type: none"> -R -R DL -RW(V) +R +R DL +RW Timer record to DVD-RAM in DR mode Disc with protect setting Destination disc for timer recording is registered already Timer recording for "One time only recording" programme is set to DVD-RAM not compatible to CPRM 	<p>—</p>
<p>The timer programme remains even after recording finishes.</p>	<ul style="list-style-type: none"> The timer programme remains if set to daily or weekly. 	<p>34</p>
<p>A part or whole of a recorded title has been lost.</p>	<ul style="list-style-type: none"> If there is a power failure or the plug is disconnected from the household mains socket while recording or editing, the title may be lost or the HDD/disc may become unusable. You will have to format the disc (HDD BD-RE RAM -RW(V) +R) or use a new disc. We cannot offer any guarantee regarding lost programmes or discs. 	<p>— 80, 84</p>
<p>Cannot copy to a disc using the high speed mode.</p>	<ul style="list-style-type: none"> High speed copying cannot be performed depending on the disc or title that is being copied. Refer to "When is the time high speed copy is not possible?" for details. 	<p>50</p>
<p>When copying, it takes a long time even when high speed mode is selected.</p>	<ul style="list-style-type: none"> Use a disc that is compatible with high speed recording. Even if the disc is high speed recording compatible, the maximum speed may not be possible due to the condition of the disc. It takes longer than normal to copy many titles. You cannot high speed copy to DVD-R titles longer than 6 hours when using other Panasonic DVD Recorders that are not compatible with EP (8 hours) mode recording. 	<p>— — —</p>
<p>An unusually loud sound is coming from the rotating disc.</p>	<ul style="list-style-type: none"> When recording or high speed copying to a disc, the sound of the disc rotating may be louder than normal, however, this is not a problem. 	<p>—</p>
<p>The quality has dropped when the title in HDD is copied to the disc.</p>	<ul style="list-style-type: none"> Titles in HD quality (titles recorded in DR mode or titles in AVCHD) will be copied as SD quality when copied to RAM -R -R DL -RW(V) +R +R DL +RW. 	<p>—</p>
<p>The DV automatic recording function does not work.</p>	<ul style="list-style-type: none"> If images cannot be recorded or if the recording is aborted, check the connections and DV equipment settings. You cannot start recording until the images from the DV equipment appear on the television. Recording may not be performed as desired if the time codes on the tape in the DV equipment are not successive. Depending on the equipment, the DV automatic recording may not operate properly. The audio/video recordings are recorded on other than a DV tape. 	<p>56 — — — 57</p>

Play		Page	
<p>Play fails to start even when [▶] (PLAY) is pressed.</p> <p>Play starts but then stops immediately.</p>	<ul style="list-style-type: none"> • Insert the disc correctly with the label facing up. • The disc is dirty. • You tried to play a blank disc or disc unplayable on this unit. • You tried to play a +RW that needs to be finalised on the equipment used for recording. • You may be able to copy a "One time only recording" title that was recorded to DVD-RAM using a different Panasonic DVD Recorder to this unit's HDD, but play is not possible due to copyright protection. 	<p>15</p> <p>15</p> <p>10</p> <p>—</p>	
	<ul style="list-style-type: none"> • When recording to DVD-RAM using "EP (8 hours)" mode, play may not be possible on DVD players that are compatible with DVD-RAM. In this case use "EP (6 hours)" mode. • You cannot playback while executing the "Recording via AV3 input" or when recording from the DV input. • Make sure that the TV is turned on. If the menu or messages are displayed, follow the on-screen instructions. 	<p>84</p> <p>—</p> <p>—</p>	
	<p>Audio and video momentarily pause.</p>	<ul style="list-style-type: none"> • This occurs between playlist chapters. • This occurs between chapters and with partially deleted titles on finalised DVD-R, DVD-R DL, DVD-RW (DVD-Video format), +R, +R DL and +RW that have been copied using the high speed mode. • This occurs as scenes change during Quick View. • R DL +R DL When playing a title recorded on both layers, the unit automatically switches between layers and plays the title in the same way as a normal programme. However, video and audio may momentarily cut out when the unit is switching layers. 	<p>—</p> <p>—</p> <p>—</p> <p>39</p>
	<p>BD-Video or DVD-Video is not played.</p>	<ul style="list-style-type: none"> • You have set a ratings level to limit BD-Video or DVD-Video play. Change this setting. • Ensure the disc is for the correct BD-Video region code or DVD-Video region number, and is not defective. • BD-V You cannot playback while recording in recording mode other than DR mode. 	<p>84</p> <p>Cover</p> <p>—</p>
	<p>Alternative soundtrack and subtitles cannot be selected.</p>	<ul style="list-style-type: none"> • The languages are not recorded on the disc. • You may not be able to use the on-screen menus to change the soundtrack and subtitles on some discs. Use the disc's menus to make changes. 	<p>—</p> <p>22</p>
	<p>No subtitles.</p>	<ul style="list-style-type: none"> • Subtitles are not recorded on the disc. • Turn the subtitles on. Set "Subtitle" on the on-screen menu to "On". 	<p>—</p> <p>76</p>
<p>Angle cannot be changed.</p>	<ul style="list-style-type: none"> • Angles can only be changed during scenes where different angles are recorded. 	<p>—</p>	
<p>You have forgotten your ratings password.</p> <p>You want to cancel the ratings level.</p>	<ul style="list-style-type: none"> • The ratings level returns to the factory preset. While the disc tray is open, press [DRIVE SELECT] to select the BD drive, then press and hold [● REC] and [▶] (PLAY) on the main unit at the same time for 5 or more seconds ("INIT" will appear on the unit's display). 	<p>—</p>	
<p>Image for the Quick View is not smooth.</p>	<ul style="list-style-type: none"> • Image may not be played back smoothly in case of DR mode titles or BD-V AVCHD. 	<p>—</p>	
<p>The resume play function does not work.</p>	<ul style="list-style-type: none"> • Memorized positions are cancelled when <ul style="list-style-type: none"> – open the disc tray. – SD CD USB turn off the power. (HDD Will not be cancelled) 	<p>—</p>	
<p>Time Slip, Manual Skip, etc. does not work.</p> <p>Slow-motion playback does not go reverse.</p> <p>Reverse frame-by-frame does not work properly.</p>	<ul style="list-style-type: none"> • Time Slip does not work when the unit's "TV System" settings are different from the title recorded on the disc. 	<p>87</p>	
	<ul style="list-style-type: none"> • Slow-motion playback in reverse does not work for title that has copied the AVCHD and BD-V AVCHD. 	<p>—</p>	
	<ul style="list-style-type: none"> • BD-V AVCHD Reverse frame-by-frame cannot be done. • Frame-by-frame backward for titles that have copied the AVCHD will be reversed in 10 frame units. 	<p>—</p> <p>—</p>	
<p>Cannot see the beginning of the title played.</p>	<ul style="list-style-type: none"> • (If connecting to a TV that supports VIERA Link with an HDMI cable) When [▶] (PLAY) is pressed on this unit's remote control, you may not be able to see the beginning of the title played until the picture is displayed on the TV. Using [◀◀], return to the beginning of the title. 	<p>—</p>	

Edit		Page
<p>Available disc space does not increase even after deleting a title.</p>	<ul style="list-style-type: none"> • Available disc space does not increase after deleting on BD-R, DVD-R, DVD-R DL, +R or +R DL. • Disc space increases only when the last recorded title is deleted on DVD-RW (DVD-Video format) and +RW. The disc space does not increase when any other titles are deleted. 	<p>26</p> <p>—</p>
<p>Cannot edit.</p>	<ul style="list-style-type: none"> • You may not be able to edit on the HDD if there is no available space. Delete any unwanted titles to create empty space. 	<p>26</p>
<p>Cannot format.</p>	<ul style="list-style-type: none"> • The disc is dirty. Wipe with a damp cloth and then wipe dry. • You tried formatting a disc that you may not be able to use in this unit. 	<p>15</p> <p>10</p>
<p>Cannot mark the start point or the end point during "Partial Delete" operation.</p>	<ul style="list-style-type: none"> • These operations are not possible with still pictures. • You cannot set points if they are too close to each other. You cannot set an end point before a start point. 	<p>—</p> <p>—</p>
<p>Cannot create a playlist.</p>	<ul style="list-style-type: none"> • Creation or editing of playlists cannot be done on this unit. 	<p>—</p>

Still pictures

Page

Cannot display Direct Navigator screen.	<ul style="list-style-type: none"> ● This screen cannot be displayed during recording or copy. 	—
Cannot edit or format a card.	<ul style="list-style-type: none"> ● Release the card's protection setting. 	11
The contents of the card cannot be read.	<ul style="list-style-type: none"> ● Remove the card from the slot and then insert again. If this does not solve the problem, turn off and turn on the unit again. 	—
	<ul style="list-style-type: none"> ● The card format is not compatible with the unit. (The contents on the card may be damaged.) This unit is compatible with SD Memory Cards that meet SD Card Specifications FAT12 and FAT16 formats, as well as SDHC Memory Cards in FAT32 format. 	11
	<ul style="list-style-type: none"> ● The card contains a folder structure and/or file extensions that are not compatible with this unit. ● You can use SD Memory Cards with capacities from 8 MB to 2 GB and SDHC Memory Cards with capacities from 4 GB to 32 GB. 	115
Copying, deleting and setting protection takes a long time.	<ul style="list-style-type: none"> ● When there are a lot of folders and files, it may sometimes take a few hours. 	—
	<ul style="list-style-type: none"> ● When repeating copying or deleting, it may sometimes take a long time. Format the disc or card. 	80

Music

Tracks could not be copied to the HDD.	<ul style="list-style-type: none"> ● If there are copyright protected tracks such as SCMS restrictions, they will not be copied. 	—
	<ul style="list-style-type: none"> ● Recording from CDs that do not conform to CD-DA specifications (copy control CDs, etc.) cannot be guaranteed. 	—
	<ul style="list-style-type: none"> ● Bonus tracks may not be copied. 	—
Title of the newly released CD cannot be acquired.	<ul style="list-style-type: none"> ● Title cannot be acquired if the title is not registered in the built-in Gracenote® database. Connection to the network is necessary to acquire title for the newly released CD. 	98
ID3 tag of a MP3 file is not completely displayed.	<ul style="list-style-type: none"> ● Only the track name and artist name can be displayed with this unit. 	—

USB

The contents of the USB memory cannot be read.	<ul style="list-style-type: none"> ● Remove the USB memory from the USB port and then insert again. If this does not solve the problem, turn off and turn on the unit again. 	—
	<ul style="list-style-type: none"> ● Check that the USB memory is inserted correctly. 	15
	<ul style="list-style-type: none"> ● The format of the USB memory or of its contents is not compatible with the unit. (The contents on the USB memory may be damaged.) 	11
	<ul style="list-style-type: none"> ● The USB memory contains a folder structure and/or file extensions that are not compatible with this unit. 	115
	<ul style="list-style-type: none"> ● Turn off and then turn on the unit again. 	—
	<ul style="list-style-type: none"> ● USB memories connected using a USB extension cable or a USB hub may not be recognized by this unit. 	—
USB memory cannot be operated.	<ul style="list-style-type: none"> ● Some USB memories cannot be used with this unit. 	11
	<ul style="list-style-type: none"> ● If inserted during playback, recording or copying etc., the USB memory may not be recognized by this unit. 	—
USB memory cannot be operated.	<ul style="list-style-type: none"> ● Turn the power of this unit off once, and turn it back on. If it cannot be operated after that, set "VIERA Link" to "Off". 	87

TV Guide		Page
The TV Guide System does not receive any data.	<ul style="list-style-type: none"> • Check whether the clock is properly set. • If signal quality is bad (ghost images or limited reception), the TV Guide system may not be able to receive any data. 	89 —
“No Data” is displayed for some or all stations.	<ul style="list-style-type: none"> • Some stations are not supported by the TV Guide system. • Programme the Timer recording manually. 	— 34
The TV Guide information is not displayed properly.	<ul style="list-style-type: none"> • There was a programme change. • Check the current programme, e.g. on the Web site for the TV Guide system provider or station provider. 	—
The TV Guide data transfer was interrupted.	<ul style="list-style-type: none"> • The TV Guide system shows the data that was received up to the interruption. • The programme information may be incomplete. 	— —
The TV Guide data is not updated.	<ul style="list-style-type: none"> • Make sure that the time is set correctly. 	89
Digital broadcast		
Digital broadcasts cannot be received.	<ul style="list-style-type: none"> • Digital broadcast may not have started in your region yet. • The aerial may not be pointing in the direction of the TV station, or the direction of the aerial may have changed due to strong winds or vibration. If problem persists consult your local TV aerial installer. 	— —
After Auto-Setup only some or no DVB channels are found.	<ul style="list-style-type: none"> • Check to ensure your area is covered by DVB transmissions. • Check that the aerial and antenna cable are designed for DVB. For your safety, the aerial and cable should be inspected/installed by a licensed installer that should comply with Australian Standard AS1417.1. If you live within 5-10 km of DVB transmission towers, a combined VHF/UHF aerial should be adequate. Outside this area, separate VHF and UHF aerials provide superior reception performance. • If you live in a unit or apartment, check to ensure the Master Antenna TV (MATV) system is designed for DVB-T reception. Please consult your body corporate. 	— — —
Picture regularly breaks up on some channels. “No signal” message is displayed.	<ul style="list-style-type: none"> • Check “DVB Signal Display”. If “Signal Quality” or “Signal Strength” are displayed in red or constantly changing, check aerial. If problem persists consult your local TV aerial installer. • Check that the aerial and antenna cable are designed for DVB. For your safety, the aerial and cable should be inspected/installed by a licensed installer that should comply with Australian Standard AS1417.1. • Interference (known as impulse noise) from household appliances such as light switches, fridges etc. may cause picture break up and/or audio distortion. Use a high quality quad shielded coaxial cable fly lead between this unit and antenna wall socket to minimise impulse noise pickup. If problem persists consult your local TV aerial installer. • Check aerial connection. • Adjust the aerial reception with “DVB Manual Tuning” in the Setup menu. 	83 — —
Picture very infrequently breaks up on some or all channels.	<ul style="list-style-type: none"> • Electrical atmospheric interference caused by local or distant lightning storms or heavy rain with wind in “leafy” locations may cause pictures to break up and audio to mute or distort momentarily. • Impulse noise interference from an infrequently used electrical appliance, or a passing vehicle or lawn mower with a “noisy” ignition system. 	— —

VIERA Link

Page

<p>VIERA Link doesn't work.</p>	<ul style="list-style-type: none"> ● Check the HDMI cable connection. Check that "HDMI" is displayed on the front display when the power for the main unit is set to On. ● Make sure that "VIERA Link" is set to "On". ● Check the "HDAVI Control" settings on the connected device. ● Some functions may not work if depending on the version of "HDAVI Control" of the connected equipment. This unit supports "HDAVI Control 3" functions. ● If the connection for the equipment connected with HDMI was changed, or if there was a power failure or the plug was removed from the household mains socket, "HDAVI Control" may not work. In this case, perform the following operations. 1 When the HDMI cable is connected to all equipment with the power on, turn the TV (VIERA) on again. 2 Change the TV (VIERA) settings for the "HDAVI Control" function to off, and then set to on again. (For more information, see the VIERA operating instructions.) 3 Switch the VIERA input to HDMI connection with this unit, and after this unit's screen is displayed check that "HDAVI Control" is working. 	<p>— 87 — — —</p>
<p>The operation on this unit (music playback etc.) is interrupted.</p>	<ul style="list-style-type: none"> ● The operation on this unit may be interrupted when you press buttons on the TV remote control that do not work for VIERA Link functions. 	<p>—</p>

To reset this unit

<p>To return all the settings other than the main ones to the factory preset</p>	<ul style="list-style-type: none"> ● Select "Yes" in "Shipping Condition" in the Setup menu. All the settings except for the ratings level and ratings password return to the factory preset. The timer recording programmes are also cancelled. ● Select "Yes" in "Default Settings" in the Setup menu. All the settings other than the tuning settings, clock settings, disc language settings, ratings level, ratings password, remote control code, network settings return to the factory presets. ● Press and hold [v CH] and [CH ^] on the main unit until the Region Selection screen appears. All the settings except for the ratings level, ratings password and clock settings return to the factory preset. The timer recording programmes are also cancelled. 	<p>89 89 —</p>
<p>To reset the ratings level settings</p>	<ul style="list-style-type: none"> ● While the disc tray is open, press [DRIVE SELECT] to select the BD drive, then press and hold [● REC] and [▶] (PLAY) on the main unit at the same time for 5 or more seconds. 	<p>—</p>
<p>To restore the unit if it freezes due to one of the safety devices being activated</p>	<ul style="list-style-type: none"> ● Press and hold [⏻/] on the main unit for 10 seconds. (The settings remain.) 	<p>—</p>

Network

<p>I can't connect to the network.</p>	<ul style="list-style-type: none"> ● Has the LAN cable come unplugged? Check that the LAN cable is properly connected. ● Have you plugged in a modular cable for use with a telephone into the LAN terminal on this unit? Connect with a straight LAN cable. ● Is the power for the modem or broadband router turned on? Turn the power on for each device. ● Is there a mistake in the network settings? Follow any instructions you may have received from your ISP (Internet Service Provider) and make changes to the settings. ● Are the broadband router settings correct? Read the operating instructions for the broadband router. ● Is the broadband router and/or modem correctly connected? Check the operating instructions for each device and connect accordingly. 	<p>98 98 — — — —</p>
<p>While using my PC, I cannot connect to the network.</p>	<ul style="list-style-type: none"> ● Does your Internet Service Provider (ISP) or service contract prevent multiple terminals connecting at the same time? Check the content of your contract. 	<p>—</p>

Other

<p>After performing an update, you can no longer receive broadcasts.</p>	<ul style="list-style-type: none"> ● Depending on the content of the update, some settings may have returned to the preset values. Fix the settings again. 	<p>—</p>
<p>Cannot set "On" in "BD-Video 24p Output".</p>	<ul style="list-style-type: none"> ● Only when the unit is connected to the HDMI terminal of a TV supporting 24p you can select "On". In some cases where the unit is connected to a TV via an amplifier/receiver through the HDMI terminals, you may not be able to select "On". In this case, connect the unit to a TV through the HDMI terminal and connect it to the amplifier/receiver through any terminal other than HDMI. 	<p>—</p>

Specifications

Recording system
BD-RE: Blu-ray Disc Rewritable Format
BD-R: Blu-ray Disc Recordable Format
DVD-RAM: DVD Video Recording format
DVD-R: DVD-Video format
DVD-R DL (Dual Layer): DVD-Video format
DVD-RW: DVD-Video format
+R
+R DL (Double Layer)
+RW

Recordable discs

BD-RE: 1-2X SPEED (Ver. 2.1)
BD-RE DL: 1-2X SPEED (Ver. 2.1)
BD-R: 1-2X SPEED (Ver. 1.1), 1-4X SPEED (Ver. 1.2),
1-2X SPEED LTH type (Ver. 1.2)
BD-R DL: 1-2X SPEED (Ver. 1.1), 1-4X SPEED (Ver. 1.2),
1-2X SPEED LTH type (Ver. 1.2)
DVD-RAM: 2X SPEED (Ver. 2.0),
2-3X SPEED (Ver. 2.1), 2-5X SPEED (Ver. 2.2)
DVD-R: 1X SPEED (Ver. 2.0), 1-4X SPEED (Ver. 2.0),
1-8X SPEED (Ver. 2.0), 1-16X SPEED (Ver. 2.1)
DVD-R DL: 2-4X SPEED (Ver. 3.0), 2-8X SPEED (Ver. 3.0)
DVD-RW: 1X SPEED (Ver. 1.1), 1-2X SPEED (Ver. 1.1),
2-4X SPEED (Ver. 1.2), 2-6X SPEED (Ver. 1.2)
+R: 2.4X SPEED (Ver. 1.0), 2.4-4X SPEED (Ver. 1.1),
2.4-8X SPEED (Ver. 1.2), 2.4-16X SPEED (Ver. 1.3)
+R DL: 2.4X SPEED (Ver. 1.0), 2.4-8X SPEED (Ver. 1.1)
+RW: 2.4X SPEED (Ver. 1.1), 2.4-4X SPEED (Ver. 1.2)

Playable discs

BD-RE: 2X SPEED (Ver. 2.1)
BD-RE DL: 2X SPEED (Ver. 2.1)
BD-R: 2X SPEED LTH type (Ver. 1.2),
2X SPEED (Ver. 1.1), 4X SPEED (Ver. 1.2)
BD-R DL: 2X SPEED LTH type (Ver. 1.2),
2X SPEED (Ver. 1.1), 4X SPEED (Ver. 1.2)
BD-Video
DVD-RAM: DVD Video Recording format, AVCHD format
DVD-R: DVD-Video format, AVCHD format*1
DVD-R DL (Dual Layer): DVD-Video format, AVCHD format*1
DVD-RW: DVD-Video format, DVD Video Recording format,
AVCHD format*1
+R, +R DL (Double Layer), +RW
DVD-Video, CD-Audio (CD-DA)
CD-R/CD-RW: CD-DA*1, MP3*1, JPEG*1

Internal HDD capacity 500 GB

Optical pick-up System with 2 lens, 3 integration units
(405 nm wavelength for BDs,
661 nm wavelength for DVDs, 783 nm wavelength for CDs)

LASER specification

Class 1 LASER Product (Pickup)

Wave length:

CD 783 nm wave length
DVD 661 nm wave length
BD 405 nm wave length

Laser power:

No hazardous radiation is emitted with the safety protection

Audio

Recording system: Dolby Digital 2ch (XP, SP, LP, EP mode),
Linear PCM (XP mode),
Dolby Digital 2ch, Max 5.1ch (DVB-T) (DR mode)
Audio in: AV1/AV2 (21 pin), AV3/AV4 (pin jack)
Input level: Standard: 0.5 Vrms, Full scale: 2.0 Vrms at 1 kHz
Input impedance: More than 10 k Ω
Audio out: AV1/AV2 (21 pin), Audio Out (pin jack)
Output level: Standard: 0.5 Vrms, Full scale: 2.0 Vrms at 1 kHz
Output impedance: Less than 1 k Ω
Digital audio out: Optical terminal (PCM, Dolby Digital, DTS, MPEG)
Coaxial terminal (PCM, Dolby Digital, DTS, MPEG)

HDMI Output

19 pin type A: 1 pc
HDMI™ (V.1.3 with Deep Colour)
• This unit supports "HDMI Control 3" function.

Video

Video system: PAL colour signal, 625 lines, 50 fields
NTSC colour signal, 525 lines, 60 fields
MPEG2 (Hybrid VBR)
Recording system: PAL colour signal, 625 lines, 50 fields
NTSC colour signal, 525 lines, 60 fields
MPEG2 (Hybrid VBR)
Video in (PAL/NTSC): AV1/AV2 (21 pin), AV3/AV4 (pin jack) 1 Vp-p 75 Ω , termination
S-Video in (PAL/NTSC): AV2 (21 pin), AV3/AV4 (S terminal) 1 Vp-p 75 Ω , termination
Video out (PAL/NTSC): AV1/AV2 (21 pin), Video Out (pin jack) 1 Vp-p 75 Ω , termination
S-Video out (PAL/NTSC): AV1 (21 pin), S-Video Out (S terminal) 1 Vp-p 75 Ω , termination
RGB out (PAL/NTSC): AV1 (21 pin) 0.7 Vp-p (PAL) 75 Ω , termination
Component video output
(NTSC 480i/480p/720p/1080i, PAL 576i/576p/720p/1080i)
Y: 1.0 Vp-p 75 Ω , termination
PB: 0.7 Vp-p 75 Ω , termination
PR: 0.7 Vp-p 75 Ω , termination

Television system

Tuner system	Channel coverage
DVB-T Australia	VHF: 6 to 12 UHF: 27 to 69

RF converter output: Not provided

SD Card

Slot: SD Memory Card slot: 1 pc
Compatible media: SD Memory Card*2, SDHC Memory Card
Format: FAT12, FAT16*3 (In case of SD Memory Card)
FAT32*3 (In case of SDHC Memory Card)

Still picture (JPEG)

Image file format: JPEG conforming DCF (Design rule for Camera File system),
Number of pixels: Between 34 × 34 and 5120 × 3840
sub sampling; 4:2:2 or 4:2:0
Thawing time: Approx. 2 sec. (8.1 M pixels, JPEG)

Video (SD Video)*4

Codec: MPEG 2 (SD-Video Entertainment Video Profile)
File Format: SD-Video format conforming

Video (HD Video)

Codec: MPEG-4 AVC/H.264
File Format: AVCHD format conforming

DV input

IEEE 1394 Standard, 4 pin: 1 pc

USB port

Type A: 1 pc
USB standard: USB 2.0 High Speed
Format: FAT16, FAT32

Video (SD Video)*4

Codec: MPEG 2 (SD-Video Entertainment Video Profile)
File Format: SD-Video format conforming

Video (HD Video)

Codec: MPEG-4 AVC/H.264
File Format: AVCHD format conforming

LAN (Ethernet) Port

10BASE-T/100BASE-TX

Others

Region code:

DVD #4
BD Region B

Operating temperature: 5 °C to 40 °C

Operating humidity range: 10 % to 80 % RH (no condensation)

Power supply: AC 220 to 240 V, 50 Hz

Power consumption: Approx. 46 W

Dimensions (W×H×D):

430 mm×59 mm×315 mm (excluding the projecting parts)

430 mm×59 mm×334 mm (including the projecting parts)

Mass: Approx. 4.3 kg

Power consumption in standby mode:

Approx. 3 W (Power Save mode)

Approx. 15 W (Quick Start mode)

Note

Specifications are subject to change without notice.

*1 Finalising is necessary for compatible playback.

*2 Includes miniSD cards. (A miniSD adaptor needs to be inserted.)
Includes microSD cards. (A microSD adaptor needs to be inserted.)

*3 Long file name is unsupported.

*4 Video Recording conversion and transfer is possible from card or Panasonic digital video camera with HDD etc, to HDD or DVD-RAM disc. After Video Recording conversion and transfer to HDD or DVD-RAM disc, the playback is possible.

● Useable capacity will be less. (SD card)

MP3

Playable media	HDD CD USB
File format	MP3 ● Files must have the extension “.mp3” or “.MP3”.
Number of folders	CD Maximum number of folders recognizable: 99 folders (including the root folder) USB Maximum number of folders recognizable: 300 folders (including the root folder)
Number of files (tracks)	CD Maximum number of files recognizable: 999 files USB Maximum number of files recognizable*1: 3000 files
Bit rates	32 kbps to 320 kbps
Sampling frequency	16 kHz/22.05 kHz/24 kHz/32 kHz/44.1 kHz/48 kHz
ID3 tags	compatible (HDD USB)

● If there is a large amount of still picture data etc. within a MP3 file, play may not be possible.

Still pictures (JPEG)*2

Playable media	HDD BD-RE RAM CD USB SD
File format	File format: JPEG ● Files must have the extension “.jpg” or “.JPG”.
Number of pixels	Between 34×34 and 5120×3840 (Sub sampling is 4:2:2 or 4:2:0)
Number of folders*3	CD Maximum number of folders recognizable: 99 folders (including the root folder) USB Maximum number of folders recognizable: 300 folders (including the root folder) HDD BD-RE RAM SD This unit can handle a maximum of 300 folders (include upper level folder)
Number of files*3	CD Maximum number of files recognizable: 999 files USB Maximum number of files recognizable*1: 3000 files RAM SD This unit can handle a maximum of 3000 files HDD BD-RE This unit can handle a maximum of 9999 files
MOTION JPEG	not supported

*1 Total number of recognizable file including MP3, JPEG and other types of files is 4000.

*2 It may take a few moments for still pictures to display.

*3 When there are many files and/or folders, some files may not display or be playable.

CD

- Compatible formats: ISO9660 level 1 or 2 (except for extended formats) and Joliet
- This unit is compatible with multi-session but reading or play of the disc may take time if there are a lot of sessions.
- Operation may take time to complete when there are many files (tracks) and/or folders and some files (tracks) may not display or be playable.
- English alphabet and Arabic numerals are displayed correctly. Other characters may not be displayed correctly.
- The display order on this unit may differ from how the order is displayed on a computer.
- Depending on how you create the disc (writing software), files (tracks) and folders may not play in the order you numbered them.
- This unit is not compatible with packet-write format.
- Depending on the recording conditions, the disc may not play.

JPEG

- Compatible formats: DCF*4 compliant (Content recorded on a digital camera, etc.)

*4 Design rule for Camera File system: unified standard established by Japan Electronics and Information Technology Industries Association (JEITA).

AVCHD

AVCHD is a new format (standard) for high definition video cameras that can be used to record and play high-resolution HD images.

BD-J

Some BD-Video discs contain Java applications, and these applications are called BD-J. You can enjoy various interactive features in addition to playing normal video.

Bitstream

This is the digital form of multi-channel audio data (e.g., 5.1 channel) before it is decoded into its various channels.

BONUS VIEW™

With the new play function of the BD-Video, you can enjoy the secondary video recorded on the disc, in addition to the main movie.

CPRM (Content Protection for Recordable Media)

CPRM is technology used to protect broadcasts that are allowed to be recorded only once. Such broadcasts can be recorded only with CPRM compatible recorders and discs.

Decoder

A decoder restores the coded audio signals on discs to normal. This is called decoding.

DNS Server

A server which acts like a telephone directory and translates Internet domain names into IP addresses.

Dolby Digital

This is a method of coding digital signals developed by Dolby Laboratories. Apart from stereo (2-channel) audio, these signals can also be multi-channel audio.

Dolby Digital Plus

Multi-channel audio and higher audio quality is made possible using Dolby Digital Plus. BD-Video supports up to 7.1 channel output.

Dolby TrueHD

Dolby TrueHD is a very high quality audio format that reproduces the studio master audio. BD-Video supports up to 7.1 channel output.

Down-mixing

This is the process of remixing the multi-channel audio found on some discs into fewer channels.

Drive

In the instance of this unit, this refers to the hard disk (HDD), disc (BD) and SD card (SD). These perform the reading and writing of data.

DTS (Digital Theater Systems)

This surround system is used in many movie theaters. There is good separation between the channels, so realistic sound effects are possible.

DTS-HD

DTS-HD is a high-quality, sophisticated audio format used in movie theaters. Previous DTS Digital Surround-compatible equipment can play DTS-HD as DTS Digital Surround audio. BD-Video supports up to 7.1 channel output.

Dynamic range

Dynamic range is the difference between the lowest level of sound that can be heard above the noise of the equipment and the highest level of sound before distortion occurs.

Dynamic range compression means reducing the gap between the loudest and softest sounds. This means you can listen at low volumes but still hear dialogue clearly.

Film and video

DVD-Videos are recorded using either film or video. This unit can determine which type has been used, then uses the most suitable method of progressive output.

Film: Recorded at 25 frames per second (PAL discs) or 24 frames per second (NTSC discs). (NTSC discs recorded at 30 frames per second as well.) Generally appropriate for motion picture films.

Video: Recorded at 25 frames/50 fields per second. (PAL discs) or 30 frames/60 fields per second (NTSC discs). Generally appropriate for TV drama programmes or animation.

Finalise

A process that makes play of a recorded CD-R, CD-RW, DVD-R, etc. possible on equipment that can play such media. You can finalise BD-R, DVD-R, DVD-R DL, DVD-RW (DVD-Video format), +R, +R DL on this unit.

After finalising, the disc becomes play-only and you can no longer record or edit. However, finalised DVD-RW can be formatted for recording again.

Folder

This is a place on the hard disk, disc or SD card where groups of data are stored together. In the case of this unit, it refers to the place where still pictures (JPEG) and MPEG2, etc. are stored.

Formatting

Formatting is the process of making media such as DVD-RAM recordable on recording equipment.

You can format BD-RE, DVD-RAM, DVD-RW (only as DVD-Video format), +RW, SD cards and the HDD or unused BD-R, +R and +R DL on this unit.

Formatting permanently deletes all contents.

Frames and fields

Frames refer to the single images that constitute the video you see on your television. Each frame consists of two fields.



- A frame still shows two fields, so there may be some blurring, but picture quality is generally better.
- A field still shows less picture information so it may be rougher, but there is no blurring.

Gateway

IP address of the electronic device providing Internet access. Usually called a router IP address. (e.g., 192.168.0.1)

HDD (Hard disk drive)

This is a mass data storage device used in computers, etc. A disk with a surface that has been treated with magnetic fluid is spun and a magnetic head is brought in close proximity to facilitate the reading and writing of large amounts of data at high speed.

HDMI (High-Definition Multimedia Interface)

Unlike conventional connections, it transmits uncompressed digital video and audio signals on a single cable. This unit supports high-definition video output [720p (750p), 1080i (1125i), 1080p (1125p)] from HDMI AV OUT terminals. To enjoy high-definition video a high definition compatible television is required.

Hub

Used for connecting more than one device to the network.

IP address

A set of numbers which distinguish each PC on the network when, for example, connected to the Internet. When using a PC in a LAN to access a PC or device that is not included in the LAN, the IP address is called the local IP address. (e.g., 192.168.0.10)

JPEG (Joint Photographic Experts Group)

This is a system used for compressing/decoding colour still pictures. If you select JPEG as the storage system on digital cameras, etc., the data will be compressed to 1/10–1/100 of its original size. The benefit of JPEG is less deterioration in picture quality considering the degree of compression.

LAN (Local Area Network)

A group of linked devices in a company, school or home. Indicates the boundaries of a particular network.

LPCM (Linear PCM)

These are uncompressed digital signals, similar to those found on CDs.

MPEG2 (Moving Picture Experts Group)

A standard for efficiently compressing and expanding colour video. MPEG2 is a compression standard used for DVD and satellite based digital broadcasting.

MPEG-4 AVC/H.264

A standard for efficiently compressing and expanding colour video. MPEG-4 AVC/H.264 is an encoding method used for recording of the high definition videos.

MP3 (MPEG Audio Layer 3)

An audio compression method that compresses audio to approximately one tenth of its size without any considerable loss of audio quality.

Pan&Scan/Letterbox

In general, BD-Video and DVD-Video are produced with the intention that they be viewed on a widescreen television (16:9 aspect ratio), so images often don't fit regular (4:3 aspect ratio) televisions. Two styles of picture, "Pan & Scan" and "Letterbox", deal with this problem.

Pan & Scan: The sides are cut off so the picture fills the screen.



Letterbox: Black bands appear at the top and bottom of the picture so the picture itself appears in an aspect ratio of 16:9.



Progressive/Interlace

Interlace is a conventional image signal that displays the image in 2 phases by splitting the display into odd and even scans. Progressive will display whole image in 1 scan. Therefore, it will give high definition image without flickering compared with interlace.

Protection

You can prevent accidental deletion by setting writing protection or deletion protection.

Router

Distinguishes the IP address assigned to each device, such as the PC, and relays the flow of data within the network.

RGB

This refers to the three primary colours of light, red (R), green (G), and blue (B) and also the method of producing video that uses them. By dividing the video signal into the three colours for transmission, noise is reduced for even higher quality images.

Sampling frequency

Sampling is the process of converting the heights of sound wave (analog signal) samples taken at set periods into digits (digital encoding). Sampling frequency is the number of samples taken per second, so larger numbers mean more faithful reproduction of the original sound.

Signal Quality

This is the guide for checking the aerial direction. The numbered values displayed do not indicate the strength of the signal, but the quality of the signal (the signal to noise ratio, or "S/N"). The channels you can receive are affected by weather conditions, seasons, time (day/night), region, length of the cable that is connected to the aerial, etc.

Subnet mask

Enables efficient network use. A set of numbers which identify which part of the IP address allocated to every device connected to the router is the network portion.

Thumbnail

This refers to a miniature representation of a picture used to display multiple pictures in the form of a list.

1080i

In one high definition image, 1080 (1125) alternating scan lines pass every 1/50th of a second to create an interlace image. Because 1080i (1125i) more than doubles current television broadcasts of 480i (525i), the detail is much clearer and creates a more realistic and rich image.

1080p

In one high definition image, 1080 (1125) scan lines pass at the same time every 1/50th of a second to create a progressive image. Since progressive video does not alternate scan lines like interlace, there is a minimal amount of screen flicker.

24p

This is a progressive image recorded at a rate of 24 frames per second.

720p

In one high definition image, 720 (750) scan lines pass at the same time every 1/50th of a second to create a progressive image. Since progressive video does not alternate scan lines like interlace, there is a minimal amount of screen flicker.

Structure of folders displayed by this unit

You can play MP3 and still pictures (JPEG) on this unit by making folders as shown below. However depending on the method of writing data (writing software), play may not be in the order you numbered the folders.

Structure of MP3 folders
CD USB
 Prefix with 3-digit numbers in the order you want to play them.

Structures of still picture folders
CD USB
 Files inside a folder are displayed in the order they were updated or taken.

BD-RE RAM

The following can be displayed on this unit.

- ***: Numbers XXX: Letters
- *1 Still pictures on the root folder can also be displayed.
- *2 Folders can be created on other equipment. However, these folders cannot be selected as a copying destination.
- If a folder name or file name has been input using other equipment, the name may not be displayed properly or you may not be able to play or edit the data.

SD Card
 ***: Numbers XXX: Letters

Safety precautions

Placement

Set the unit up on an even surface away from direct sunlight, high temperatures, high humidity, and excessive vibration. These conditions can damage the cabinet and other components, thereby shortening the unit's service life.

Do not place heavy items on the unit.

Voltage

Do not use high voltage power sources. This can overload the unit and cause a fire.

Do not use a DC power source. Check the source carefully when setting the unit up on a ship or other place where DC is used.

AC mains lead protection

Ensure the AC mains lead is connected correctly and not damaged. Poor connection and lead damage can cause fire or electric shock. Do not pull, bend, or place heavy items on the lead.

Grasp the plug firmly when unplugging the lead. Pulling the AC mains lead can cause electric shock.

Do not handle the plug with wet hands. This can cause electric shock.

Foreign matter

Do not let metal objects fall inside the unit. This can cause electric shock or malfunction.

Do not let liquids get into the unit. This can cause electric shock or malfunction. If this occurs, immediately disconnect the unit from the power supply and contact your dealer.

Do not spray insecticides onto or into the unit. They contain flammable gases which can ignite if sprayed into the unit.

Service

Do not attempt to repair this unit by yourself. If sound is interrupted, indicators fail to light, smoke appears, or any other problem that is not covered in these instructions occurs, disconnect the AC mains lead and contact your dealer or an authorized service centre. Electric shock or damage to the unit can occur if the unit is repaired, disassembled or reconstructed by unqualified persons.

Extend operating life by disconnecting the unit from the power source if it is not to be used for a long time.

Java and all Java-based trademarks and logos are trademarks or registered trademarks of Sun Microsystems, Inc. in the United States and other countries.

Manufactured under license from Dolby Laboratories. Dolby and the double-D symbol are trademarks of Dolby Laboratories.

"DTS" is a registered trademark of DTS, Inc. and "DTS-HD Advanced Digital Out" is a trademark of DTS, Inc.

This product incorporates copyright protection technology that is protected by U.S. patents and other intellectual property rights. Use of this copyright protection technology must be authorized by Macrovision, and is intended for home and other limited viewing uses only unless otherwise authorized by Macrovision. Reverse engineering or disassembly is prohibited.

- SDHC Logo is a trademark.
- Portions of this product are protected under copyright law and are provided under license by ARIS/SOLANA/4C.

HDMI, the HDMI logo and High-Definition Multimedia Interface are trademarks or registered trademarks of HDMI Licensing LLC.

This product is licensed under the AVC patent portfolio license and VC-1 patent portfolio license for the personal and non-commercial use of a consumer to (i) encode video in compliance with the AVC Standard and VC-1 Standard ("AVC/VC-1 Video") and/or (ii) decode AVC/VC-1 Video that was encoded by a consumer engaged in a personal and non-commercial activity and/or was obtained from a video provider licensed to provide AVC/VC-1 Video. No license is granted or shall be implied for any other use. Additional information may be obtained from MPEG LA, LLC. See <http://www.mpegla.com>.

"AVCHD" and the "AVCHD" logo are trademarks of Matsushita Electric Industrial Co., Ltd. and Sony Corporation.

HDAVI Control™ is a trademark of Matsushita Electric Industrial Co., Ltd.

"Blu-ray Disc" is trademark.

"BONUSVIEW" is trademark of Blu-ray Disc Association.

Gracenote® Corporate Description

Music recognition technology and related data are provided by Gracenote®. Gracenote is the industry standard in music recognition technology and related content delivery. For more information visit www.gracenote.com.

Gracenote® Proprietary Legends

CD and music-related data from Gracenote, Inc., copyright © 2000–2008 Gracenote. Gracenote Software, copyright © 2000–2008 Gracenote. This product and service may practice one or more of the following U.S. Patents: #5,987,525; #6,061,680; #6,154,773, #6,161,132, #6,230,192, #6,230,207, #6,240,459, #6,330,593, and other patents issued or pending. Some services supplied under license from Open Globe, Inc. for U.S. Patent: #6,304,523.

Gracenote and CDDB are registered trademarks of Gracenote. The Gracenote logo and logotype, and the “Powered by Gracenote” logo are trademarks of Gracenote.



Gracenote® End-User License Agreement

USE OF THIS PRODUCT IMPLIES ACCEPTANCE OF THE TERMS BELOW.

This application or device contains software from Gracenote, Inc. of Emeryville, California (“Gracenote”). The software from Gracenote (the “Gracenote Software”) enables this application to perform disc and/or file identification and obtain music-related information, including name, artist, track, and title information (“Gracenote Data”) from online servers or embedded databases (collectively, “Gracenote Servers”) and to perform other functions. You may use Gracenote Data only by means of the intended End-User functions of this application or device.

You agree that you will use Gracenote Data, the Gracenote Software, and Gracenote Servers for your own personal non-commercial use only. You agree not to assign, copy, transfer or transmit the Gracenote Software or any Gracenote Data to any third party. YOU AGREE NOT TO USE OR EXPLOIT GRACENOTE DATA, THE GRACENOTE SOFTWARE, OR GRACENOTE SERVERS, EXCEPT AS EXPRESSLY PERMITTED HEREIN.

You agree that your non-exclusive license to use the Gracenote Data, the Gracenote Software, and Gracenote Servers will terminate if you violate these restrictions. If your license terminates, you agree to cease any and all use of the Gracenote Data, the Gracenote Software, and Gracenote Servers. Gracenote reserves all rights in Gracenote Data, the Gracenote Software, and the Gracenote Servers, including all ownership rights. Under no circumstances will Gracenote become liable for any payment to you for any information that you provide. You agree that Gracenote, Inc. may enforce its rights under this Agreement against you directly in its own name.

The Gracenote service uses a unique identifier to track queries for statistical purposes. The purpose of a randomly assigned numeric identifier is to allow the Gracenote service to count queries without knowing anything about who you are. For more information, see the web page for the Gracenote Privacy Policy for the Gracenote service.

The Gracenote Software and each item of Gracenote Data are licensed to you “AS IS.”

Gracenote makes no representations or warranties, express or implied, regarding the accuracy of any Gracenote Data from in the Gracenote Servers. Gracenote reserves the right to delete data from the Gracenote Servers or to change data categories for any cause that Gracenote deems sufficient. No warranty is made that the Gracenote Software or Gracenote Servers are error-free or that functioning of Gracenote Software or Gracenote Servers will be uninterrupted. Gracenote is not obligated to provide you with new enhanced or additional data types or categories that Gracenote may provide in the future and is free to discontinue its services at any time.

GRACENOTE DISCLAIMS ALL WARRANTIES EXPRESS OR IMPLIED, INCLUDING, BUT NOT LIMITED TO, IMPLIED WARRANTIES OF MERCHANTABILITY, FITNESS FOR A PARTICULAR PURPOSE, TITLE, AND NON-INFRINGEMENT. GRACENOTE DOES NOT WARRANT THE RESULTS THAT WILL BE OBTAINED BY YOUR USE OF THE GRACENOTE SOFTWARE OR ANY GRACENOTE SERVER. IN NO CASE WILL GRACENOTE BE LIABLE FOR ANY CONSEQUENTIAL OR INCIDENTAL DAMAGES OR FOR ANY LOST PROFITS OR LOST REVENUES.

-If you see this symbol-

Information on Disposal in other Countries outside the European Union



This symbol is only valid in the European Union. If you wish to discard this product, please contact your local authorities or dealer and ask for the correct method of disposal.

Adjust the audio quality (Sound menu)	77
Adjust the picture quality (Picture menu)	76
Advanced Copy	52
Album (Music)	
Edit	69
Play	67
Album (Still picture)	
Copy	63
Edit	62
Play	60
Angle	76
Aspect	77
Audio	
Digital broadcast	20
Playback	39
Auto Renewal Recording	35
AVCHD	114
Copy	58
Play	41
AV2 Input	88
BONUS VIEW™	42
Change Thumbnail	45
Channel	
Select	20
Settings	82
Chapter	46
Chasing playback	32
Child Lock	92
Cleaning	
Disc	15
Lens	14
Main unit	14
Clock Settings	89
Connection	
Aerial	16, 96, 97
Amplifier	94, 95
COMPONENT VIDEO terminals	94
Digital input terminal	94
DV input terminal	56
HDMI	17, 95
Network	98
S VIDEO terminals	94
Television	16, 17, 95–97
Video cassette recorder	96, 97
VIDEO terminals	16, 96, 97
Copy	
HD Video	58
Music	71
SD Video	59
Still picture	64
Title	27, 48–54
Copy Navigator	27
Copy Title Playing	51
CPRM	114
Create Chapter	46
Delete	
Album (Music)	72
Album (Still picture)	72
All titles (Discs)	80
All titles (HDD)	84
Chapter	47
Still picture	72
Title	26
Track	72
Digital Audio Output settings	85
Digital broadcast	
Digital channel information	21
DVB Signal Display	83
Multi Audio	20
Subtitle	20
New service	83
Select the channel	20
Direct Navigator	
Music	67
Still picture	60
Title	22
Discs	
Discs you can use for recording and play	8
Play-only discs	10
Discs that cannot be played	10
Disc name	79
Format	80
Protection	79
Display	
Digital channel information	21
Status messages	77
Divide Title	45
DR (Direct Recording mode)	7, 30
DV automatic recording	57
DVB Signal Display	83
Edit	
Chapter	47
Music on HDD	69
Still picture	62
Title	44
Enabling discs to be played on other equipment	
–Finalise	81
Finalise	81, 114
Flexible Recording	32
Format	80, 114
FR (Flexible Recording Mode)	30
FUNCTION MENU window	78
Glossary	114
Gracenote® database	71
HDD	
Format	84
Handling care	14
HDMI	114
Connecting with a Receiver	95
Connecting with a TV	17
Settings (HDMI Connection)	87
HD Video	
Copy	58
Play	41
High Speed Copy	84
Initialize	89
JPEG	114
Language	
Code list	101
Disc menu	76, 84
Soundtrack	76, 84
Subtitle	76, 84
LPCM	86, 114
Manual Skip	39
Menu	
Setup	82
Mode	
Recording	30
Still Mode	85
MPEG2	114
Copy	59
Music	
Copy	71
Delete	72
Edit	69
Play (CD)	66
Play (MP3)	66
Play (Music on HDD)	67
Name	
Album (Music)	69
Album (Still picture)	63
Disc	79
Entering text	73
Title	34, 45
Network	
Connection	98
Settings	90
New service	83
One Touch Recording	23
Partial Delete	45
Pause Live TV	78
VIERA	75
Playing back	
BD-Video/DVD-Video	22
HD Video	41
Music	66
Still picture	60
Title	22
Playlist	
Music	67
Title	41
Pop-up menu	42
Power Save	89
Progressive	76, 115

Properties	
Music	68
Still picture	61
Title	45
Protection	
Album (Still picture)	63
Card	11
Disc	79
Still picture	63
Title	45
Quick Start	89
Quick View	38
Ratings level	
BD-Video	84
DVD-Video	84
Recording	23
Aspect	84
Auto Renewal	35
DV automatic recording	57
Flexible Recording	32
Important notes	28
Mode	30
Recording via AV3 input	57
Relief	35
Timer	24, 34–37
Recording via AV3 input	57
Relief Recording	35
Remote control code	89
Repeat Play	76
Resume play function	38
SD card	
Copy (HD Video)	58
Copy (SD Video)	59
Copy (Still picture)	64
Format	80
Insert	15
Play (HD Video)	41
Play (Still picture)	60
Supported formats	11
SD Video	
Copy	59
Select channel	20
Setup menu	82
Simultaneous rec and play	32
Slide show	61
Software Update	93
Soundtrack	76
Speaker	88
Specifications	112
Still picture	
Copy	64
Edit	62
Play	60
Subtitle	
Digital broadcast	20
Disc	76
Playback	39
Switch the audio/subtitles on the disc (Disc menu)	76
Teletext	21
Time Slip	39
Timer recording	
Check, change or delete a programme	36
Manual Recording	34
Using the TV Guide System	24
Title	
Copy	27, 48–54
Delete	26
Edit	44
Play	22
Protection	79
Tuning	82
TV Guide	24, 37
TV System (PAL/NTSC)	87
USB	
Copy (HD Video)	58
Copy (Music)	71
Copy (SD Video)	59
Copy (Still picture)	64
Insert	15
Play (Still picture)	60
Supported formats	11

VIERA Link (HDAVI Control)	
Connection	17
Operation	74
Settings	87
2 programmes simultaneous recording	31

